

Celebrating

60

years of innovation

1964 - 2024



INVEST IN THE FUTURE



French manufacturer
since 1964

Collision Repair

Solutions Réparation Carrosserie

Karosseriereparatur

Attrezzature Riparazione Carrozzerie

Reparación de Carrocería

2024B



SPOT WELDING - DENT PULLER - MIG-MAG/GMAW-FCAW - PLASMA CUTTING -
INDUCTION - RIVETING - LIFT - BODYSHOP TOOLS

A solid manufacturing group

900 people € 130 000 000

C1+ Credit Rating Banque de France
55 000 m² 2 factories



INVEST IN THE FUTURE



French manufacturer since 1964

A family company



Nicolas & Bruno Bouygues



Welding, Plasma cutting & Induction heating



Collision repair



Chargers, Boosters & Starters

A worldwide coverage

125 countries



GYS FRANCE Laval

GYS GERMANY Aachen

GYS U.K. Rugby

GYS CHINA Shanghai

GYS ITALIA Venezia

GYS IBERICA Madrid

www.gys.fr



visit with



DENT PULLING

GYS POT	6
GYS POT PRO	7
GYS POT ALU	8
GYS POT COMBI	9
ACCESSORIES & CONSUMABLES	10
GYS POT ARCPULL	12
COMBI ARCPULL	13
ACCESSORIES & CONSUMABLES	16
FAST EASY TOOLS	18
ACCESSORIES LEVELLING BARS	20
COMPLETE WORKSTATIONS	24

PULLING SYSTEMS

AIRFIX DRAW ALIGNER	38
DRAW ALIGNER	40
FRAME STRAIGHTENING	42

PAINTLESS DENT REPAIR

POWERDUCTION AUTO DENT REPAIR	46
GLUE PULLING REPAIR	50

SPOT WELDING

TECHNOLOGY	54
PORTASPOT / GYS POT 32D-X / 100R-CX	56
GYS POT BP GENIUS	58
GYS POT PTI-S7 / PTI PREMIUM PRO	60
GYS POT PTI GENIUS	62
GYS POT PTI NEO	64
GYS POT PTI MASTER / PTI EXPERT	66
G ARMS	68
ACCESSORIES & CONSUMABLES	69
X ARMS / C ARMS	70

RIVETING

GYS PRESS 10T	73
GYS PRESS PREMIUM 10T PP	75
WORKSTATION	76
ADAPTERS	78
DIES BOXES & RIVETS	80
ACCESSORIES	83

MIG WELDING

GYS AUTO	86
E GYS AUTO	88
P GYS AUTO	90
AUTOPULSE	92
TORCHES & CONSUMABLES	96

PLASMA

EASYCUT K	101
EASYCUT	102
CUTTER	103

INDUCTION HEATING

GYS DUCTION	106
COMBI DUCTION	107
POWER DUCTION	108
ACCESSORIES & CONSUMABLES	112

TRUCK TOOLS & MOBILE LIFTS

TROLLEY IW1	115
MULTITOOL TRUCK	115
SPOT LIFT	116
QUICKLIFT / AIR JACKS	118
ERGO LIFT	119
MANUAL DOOR LIFT / MANUAL WHEEL LIFT	120

ACCESSORIES

WELDING HELMETS	122
FUME EXTRACTION	125
WINDSCREEN REPAIR	123
BUMPER REPAIR	128
HAND TOOLS	130
PNEUMATIC TOOLS	134
WORKING LIGHTS	136
SANDING & DUST EXTRACTION	138
WORKING SUPPORTS	140
ELECTRIC VEHICLES	144
SAFETY PROTECTION	146



DENT PULLING

STEEL / ACIER / STAHL

GYSPOT	6
GYSPOT PRO	7

ALU

GYSPOT ALU	8
------------	---

ALU + STEEL / ACIER / STAHL

GYSPOT COMBI	9
ACCESSORIES & CONSUMABLES	10

DRAWN ARC ALU + STEEL / ACIER / STAHL

GYSPOT ARCPULL	12
COMBI ARCPULL	13
ACCESSORIES & CONSUMABLES	16

FAST DENT PULLING	18
-------------------	----

LEVELLING BARS	20
----------------	----

COMPLETE WORKSTATIONS	24
-----------------------	----



GYSPOT

DENT PULLING STEEL ACIER - STAHL

- Stars - Étoiles - Ausbeulstern
- Rings - Anneaux - Zugösen
- Wavy wires - Fils ondulés - Wellendraht
- Impact shrinking - Rabattage d'impact - Glätten

OPTIONS

Consommables - Consumables p.10



Chariots - Trolleys p.24



- Stars - Étoiles - Ausbeulstern
- Rings - Anneaux - Zugösen
- Wavy wires - Fils ondulés - Wellendraht
- Impact shrinking - Rabattage d'impact - Glätten

- Tempering - Rétreinte - Temperieren



FIXED GUN

FIXED GUN

GYSPOT 26.02

2600 A x1 **AUTOMATIC**

230V • 1~

052208

included

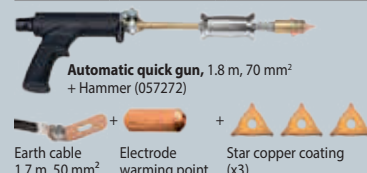

Earth cable 1.7 m, 50 mm² Electrode warming point Star copper coating (x3)

GYSPOT 27.02

2600 A x1 **MANUAL**

230V • 1~

055353

included

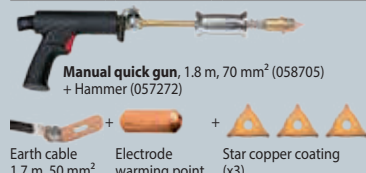

Earth cable 1.7 m, 50 mm² Electrode warming point Star copper coating (x3)

GYSPOT 34.02 & 34.04

3500 A x1 **MANUAL**

230V • 1~

GYSPOT 34.02
065741

400V • 2~

GYSPOT 34.04
067943

included

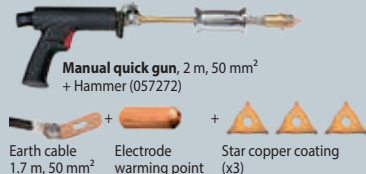

Earth cable 1.7 m, 50 mm² Electrode warming point Star copper coating (x3)

- Stars - Étoiles - Ausbeulstern
- Rings - Anneaux - Zugösen
- Wavy wires - Fils ondulés - Wellendraht
- Impact shrinking - Rabattage d'impact - Glätten
- Tempering - Rétreinte - Temperieren
- Rivets - Rivets - Nieten
- Rings - Rondelles - Unterlegscheiben
- Studs - Goujons - Gewindebolzen

SYNERGIC CONTROL

PATENTS REGISTERED NUMBERS EUROPEAN TRADEMARK & DESIGN



GUN WITH CONNECTOR

GYSPOT 39.02 & 39.04

3800 A x1 **AUTOMATIC**

230V • 1~

GYSPOT 39.02
052215

400V • 2~

GYSPOT 39.04
052222

included

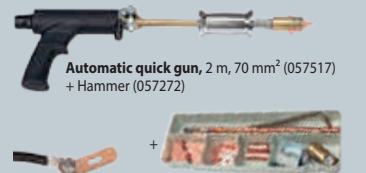

Earth cable 2 m, 70 mm² SPOTTER BOX STANDARD (053915) (Details p.10)

GYSPOT PRO 230 & PRO 400

3800 A x2 **AUTOMATIC**

230V • 1~

GYSPOT PRO 230
052178

400V • 2~

GYSPOT PRO 400
052185

included

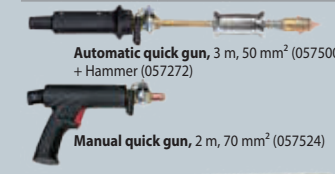

Earth cable 2 m, 70 mm² SPOTTER BOX PRO (050075) (Details p.10)

GYSPOT EXPERT 200, 230 & 400

3800-4500 A x2 **AUTOMATIC**

230V • 1~

GYSPOT EXPERT 230
066885

200-240V • 1~

GYSPOT EXPERT 200
058842

4350 > 5100 A

GYSPOT EXPERT 400
058859

included

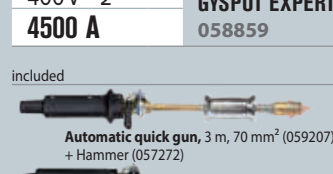

Earth cable Thick 3 mm 2 m, 70 mm² SPOTTER BOX PRO (050075) (Details p.10)

QUICK GUNS

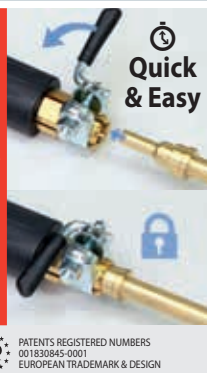

Quick & Easy

AUTOMATIC



WITH CONNECTOR
2 m, Ø 70 mm²
included 39.02/04
057517



WITH CONNECTOR
3 m, Ø 50 mm²
included PRO 230/400
057500

WITH CONNECTOR
3 m, Ø 70 mm²
included EXPERT 200/230/400
059207

MANUAL



WITH CONNECTOR
cable 2 m, Ø 70 mm²
included PRO 230/400,
EXPERT 200/230/400,
COMBI 230EPRO
057524

No connector
cable 1.8 m, Ø 70 mm²
for 27.02
058705

No connector
cable 2 m, Ø 50 mm²
for 34.02/34.04

Mandrels for gun - Mandrins pour pistolets - Pistole & Anschlußstücke, Zubehör



QUICK GUN
057531



D1
048959



Nut - Écrou
053199

Microswitch
053267

	G NORM 62135	50/60 Hz	I ₂ max	U ₂	I _{AM}	I _{RMS}	kW	OK	OK	MANUAL	SYNERGIC	AUTOMATIC	MANUAL	SEPARATE CABLE GUN	LxWxH cm / kg
GYSPOT 26.02	230V	2 m	2600	5,4	16	1800	10	OK	—	—	—	—	—	—	40 x 25 x 31 / 18
GYSPOT 27.02	230V	2 m	2600	5,4	16	1800	10	OK	—	—	—	—	—	—	40 x 25 x 31 / 18
GYSPOT 34.02	230V	2 m	3500	7,4	16	2500	20	OK	OK	—	—	—	—	—	42 x 36 x 31 / 23.9
GYSPOT 34.04	400V, 2ph	4 m	3500	7,4	16	2500	20	OK	OK	—	—	—	—	—	42 x 36 x 31 / 24
GYSPOT 39.02	230V	4 m	3800	7,4	16	2800	20	OK	OK	—	—	—	—	—	49 x 38 x 29 / 27.5
GYSPOT 39.04	400V, 2ph	4 m	3800	7,4	16	2800	20	OK	OK	—	—	—	—	—	49 x 38 x 29 / 25.2
GYSPOT PRO 230	230V	8 m	3800	7,4	16	2800	20	OK	OK	—	—	—	—	—	49 x 38 x 29 / 29.6
GYSPOT PRO 400	400V, 2ph	8 m	3800	7,4	16	2800	20	OK	OK	—	—	—	—	—	49 x 38 x 29 / 29.4
GYSPOT EXPERT 200	200-240V	8 m	4350 > 5100	7,2-8,7	30(D)	3100 > 3600	25 > 36	OK	OK	—	—	—	—	—	49 x 38 x 29 / 34.6
GYSPOT EXPERT 230	230V	8 m	3800	7,4	16	2800	20	OK	OK	—	—	—	—	—	49 x 37 x 31 / 30.6
GYSPOT EXPERT 400	400V, 2ph	8 m	4500	7,4	16(D)	3200	25	OK	OK	—	—	—	—	—	49 x 38 x 29 / 32.9

GYSPOT

STEEL DENT PULLING



GYS POT ALU

DENT PULLING ALU



SYNERGIC CONTROL

PATENTS REGISTERED NUMBERS
EUROPEAN TRADEMARK & DESIGN



Goujons - Studs

NEW



FIXED GUN

GYS POT ALU 66

13000 A x1 AUTOMATIC

230V • 1~ AD

080188

included for Ø 4 mm



AD ANTI-DUST

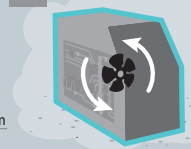

GYS POT ALU PRO FV

13000 A x1 AUTOMATIC

110 > 230V • 1~ FV

021990

included for Ø 4 mm



FV FLEXIBLE VOLTAGE

85 V ← 265 V

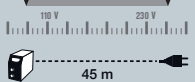

ALU GUN

AUTOMATIC



3 m, Ø 25 mm²

included SPOT ALU FV & COMBISLOT 230

054066

(x 3)
065635

66 mF CAPACITOR DISCHARGE WELDING

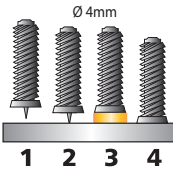

Joint rings for mandrel Ø 4/5/6 x 2
060814

PATENTS REGISTERED NUMBERS
002446450-0001
EUROPEAN TRADEMARK & DESIGN

OPTIONS

Consumables - Consommables p.11



ALU accessories - Accessoires ALU p.19



Trolleys - Chariots p.24



GYS POT COMBI

DENT PULLING ALU+STEEL ACIER - STAHL

PATENTS REGISTERED NUMBERS
EUROPEAN TRADEMARK & DESIGN

Steel / Acier / Stahl

Alu



- Stars - Étoiles
- Rings - Anneaux
- Wavy wires - Fils ondulés
- Impact shrinking - Rabattage d'impact
- Tempering - Rétreinte
- Rivets - Rivets
- Rings - Rondelles
- Studs - Goujons

2 GUNS INCLUDED



GUN WITH CONNECTOR

GYS POT COMBI 230 E.PRO

3800 A Acier / Steel / Stahl

13000 A Alu

230V • 1~

AUTOMATIC
MANUAL
x2
AUTOMATIC

021266

included

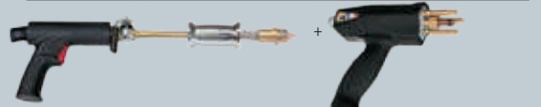

Manual quick gun, 2 m, 70 mm² (057524) + Hammer (057272)

Automatic alu gun, 3 m, 25 mm²



Earth cable 2 m, 70 mm²

SPOTTER BOX PRO (050075) (Details p.10)

ALU BOX STANDARD (050020) (Details p.11)

				I_2 max	U_2	I_{AM}	RMS	kW			MANUAL	SYNERGIC			AUTOMATIC	MANUAL	SEPARATE CABLE GUN			LxWxH cm / kg
MADE IN GYS CHINA	GYS POT ALU 66	62135	50/60 Hz	A	V	A	A	0.52	OK	OK	MANUAL	■	■	■	x1	—	—	3 m	Included Alu box	27 x 20.5 x 27 / 13.5
MADE IN FRANCE	GYS POT ALU PRO FV		110 > 230V	13 000	50 > 200	5	—	0.65	OK	OK	■	■	■	■	x1	—	—	3 m	Included Alu box	49 x 38 x 29 / 13.4
	GYS POT COMBI 230 E.PRO		230V	3800 (steel) 13000 (alu)	7,4 (steel) 50 > 200 (alu)	16	2800 (steel)	20	OK	OK	—	■	■	■	x1	x1	■	2/3 m	Included Spotter box + Alu box	54 x 76 x 34 / 47.5

GYS POT

ALU + STEEL DENT PULLING



STEEL / ACIER / STAHL



DENT BOX
CONSUMABLES / BAR / EASY



SPOTTER BOX
STANDARD / 2600 / 2700

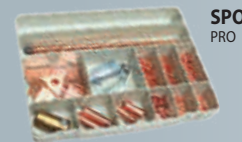

SPOTTER BOX
PRO

	hexagon	Earth plate small	chuck for inertia hammer	copper coating star	electrode ø 16 for 8 x 16	ø 8 x 16	earth hook	carbon heating electrode	electrode warming point ø 16	Ball electrode warming point Ø16	M8	elec-trode	wavy wire	magnetic positioner	elec-trode	straight rings	twisted rings	lifting rod	electrode for threaded studs rivets ø 5 - M5, M6	threaded M5 x 18 x 0.8	self-threading ø 5 x 18	ø 5 x 12	electrode ø 16, 3 x 4,50	ø 3 x 3.25	ø 3 x 4.50	electrode ø 2 - M4	ø 2	electrode wheel ø 16	flat n°27	Earth plate large	magnetic	Steel gun earth adapter Ø 25 mm
			x1	x20	x1	x100	x1	x5	x1	x1	x100	x1	x50	x1	x1	x100	x1	x50	x1	x100	x100	x100	x1	x100	x100	x1	x100	x1	x1	x1	x1	x1
			049482	052239	049574	049444	056718	049468	049567	059726	050303	049789	049727	049772	050655	050648	050631	050792	049598	049383	049420	049413	049604	049345	049352	049277	041561	050310	049673	052529	049666	051997

DENT BOX

CONSUMABLES

051515

x20

BAR

050037



x25

x50 x25

EASY

053632



x1

x25

x1

x50

x1

180mm

SPOTTER BOX

PRO

050075



x1

x1

x1

x20

x1

x50

x1

x1

x1

x1

x50

x50

x50

x1

x100

x100

STANDARD

053915

x1

x1

x1

x20

x1

x50

x1

x1

x1

2600

052277



x20

x1

x50

x1

2700

053922



x20

x1

x50

x1

x1



ELECTRODE FOR
MAGNETIC EARTH (x1)
050013



SINGLE HOOK
(x1)
051218

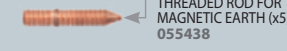

THREADED ROD FOR
MAGNETIC EARTH (x5)
055438

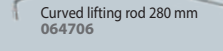

Curved lifting rod 280 mm
064706



Steel Ring sharpener
- Affuteur d'anneaux acier
- Stahl Zugöseschneider
072565

SLIDE HAMMERS - Marteaux inertie - Ausbeulhammer

COMPLETE

057272



1.1 kg

049802

included (x1)

049482

included (x20)

052239

COMPLETE KIT

051225

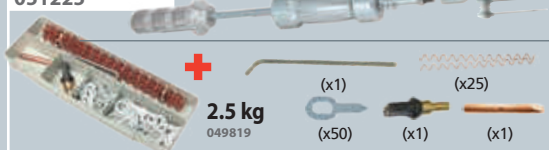

2.5 kg

049819

(x1)

049819

(x25)

049819

(x1)

049819

(x1)

049819

Nails - Clous - Nägel

041813

1.1 kg

Ø 2, M4 (x1)
049277Ø 2 (x100)
041561MIG/MAG nozzle
for Nail welding
041523

Washers - Rondelles - Ringe

051201

1.7 kg

Ø 16, 8x16 (x1)
0495748x16 (x100)
049444(x1)
051218

Slide hammer kit - Kit marteau à inertie - Ausbeulhammerset

051928

6 kg



Pulling handle 3 claws - Poignée de tirage 3 dents - Handzugkralle 3-fach

057326

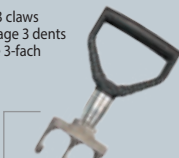

057326

Pulling handle with hook - Poignée de tirage avec crochet

057319

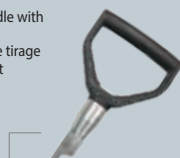

057319

ALU

Joint rings for mandrel Ø 4/5/6
x2
060814

	mandrel for ALU GUN	alu magnesium screws 12 mm	alu silicium screws 12 mm	screwable rings ø4 x5	fast pulling rings x5	lifting rod x3: 180, 300, 500 mm								
	ø 4 x2 049000	ø 5 x1 048157	ø 6 x1 048164	ø 4 - M4 x200 050273	ø 4 - M4 x1000 050129	ø 5 x100 048140	ø 6 x100 048133	ø 4 - M4 x200 050280	ø 4 - M4 x1000 050136	ø 5 x100 048126	ø 6 x100 048003	ø 4 x5 050297	x5 058712	x3: 180, 300, 500 mm 050792
LIGHT Ø 4 051522				x4	x200	x4	x200							
STANDARD Ø 4 050020				x4	x200	x4	x200						x5	x1
Ø 5 & 6 048195	x1	x1				ø 5 x100 + ø 6 x100	ø 5 x100 + ø 6 x100						x5	

ALU BOX

LIGHT Ø 4

051522

STANDARD Ø 4

050020

included GYSPOT ALU & COMBI 230

Ø 5 & 6

048195



DENT PULLING DRAWN ARC ALU + STEEL

ACIER - STAHL



MANUAL

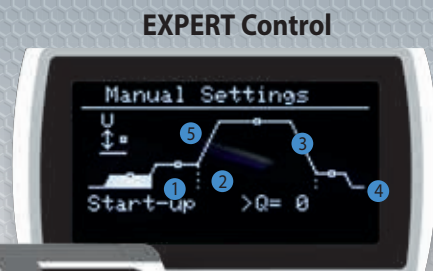

- 1 Start-up - Amorce - Zündung
- 2 Scouring (I & t) - Décapage - Abbeizen
- 3 Arc (I & t) - Arc - Lichtbogen
- 4 Hitching (I & t) - Accroche - Verklebung
- 5 Height - Hauteur - Höhe

- Rings - Anneaux - Zugösen
- Studs - Goujons - Gewindebolzen
- Stainless steel nails - Tiges inox - Edelstahlnägel



7 languages
FR, EN, DE, SP, IT, NL & RU

SYNERGIC DIGITAL GUNS

★★★★★
UNIQUE Linear Motor

DRAWN ARC PROCESS
Gas protection

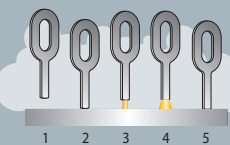

3 m, Ø 25 mm²
included
ARCPULL 200 & 350,
COMBI ARCPULL



Full control



Consumables for Gun



FV FLEXIBLE VOLTAGE

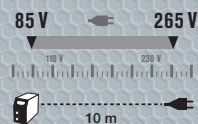

SR SECONDARY REGULATION

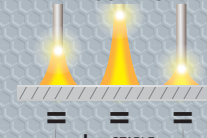

AD ANTI-DUST

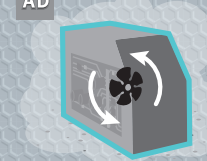

MANUAL & SYNERGIC CONTROL



Ø max
Alu : 6 mm
Fe : 6 mm



GUN WITH CONNECTOR

GYSPOT ARCPULL 200 CAR BODY REPAIR

100 · 230V · 1~
200 A **T x1 MANUAL**
FV SR AD
057470
included

- Manual synergic gun 3 m, 25 mm² (Alu Spec + AIMg3 + AIMgSi) 059429
- ALU RING BOX 1.5 mm (Alu Spec + AIMg3 + AIMgSi) 059429
- Lifting rod 180 mm (x1) 082915

OPTIONS details p.24
Weld 810 for ARCPULL 200 037489

GYSPOT COMBI ARCPULL

230V · 1~	
ARCPULL 200 A Alu	EXPERT 3800 A Acier / Steel / Stahl
T x1 MANUAL	T x1 MANUAL

- 069824
Arccpull accessories included
- Manual synergic gun 3 m, 25 mm² (Alu Spec + AIMg3 + AIMgSi) 059429
 - ALU RING BOX 1.5 mm (Alu Spec + AIMg3 + AIMgSi) 059429
 - Lifting rod 180 mm (x1) 082915

- Expert accessories included
- Manual quick gun, 2 m, 70 mm² (057524) + Hammer (057272)
 - Earth cable 2 m, 70 mm²
 - SPOTTER BOX PRO (050075) (Details p.10)

MADE IN FRANCE 60974-1	50/60 Hz	I ₂ A	SYNERGIC			MANUAL		IRMS (A)	GUN		U ₂ V	kW	A	OK	OK	LxWxH cm / kg
			SYNERGIC	MANUAL	IRMS (A)	Acier/Steel	Alu									
GYSPOT ARCPULL 200 CAR BODY REPAIR	110 · 230V	6 m	10 · 100 (110 V) 10 · 200 (230 V)	■	■	—	Manual + Digital Gun Motion Control	Acier/Steel	Alu	20.4 · 24 V (110 V) 20.4 · 28 V (230 V)	16	2.4 (110 V) 5.6 (230 V)	OK	OK	49 x 37 x 30 / 14.5	
GYSPOT COMBI ARCPULL	230V	8 m	Alu 10 · 200 Acier 3800	■	■	Steel 3800	Manual Automatic (not included)	Manual	Manual	Alu 20.4 · 28 V Steel 7.4 V	16	Alu 5.6 Steel 20	OK	OK	72 x 42 x 29 / 41.5	



GYS POT ARCPULL

DENT PULLING DRAWN ARC ALU + STEEL ACIER - STAHL

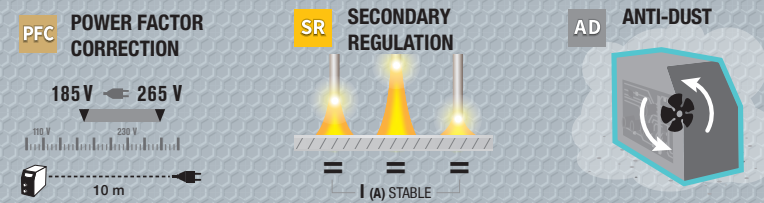

- SYNERGIC: Rings - Anneaux - Zugösen, Studs - Goujons - Gewindebolzen, Stainless steel nails - Tiges inox - Edeltahlnägel
- EXPERT Control: 1 Start-up - Amorce - Zündung, 2 Scouring (I & t) - Décapage - Abbeizen, 3 Arc (I & t) - Arc - Lichtbogen, 4 Hitching (I & t) - Accroche - Verklebung, 5 Height - Hauteur - Höhe



7 languages
FR, EN, DE, SP, IT, NL & RU



SYNERGIC DIGITAL GUNS

★★★★★ **DRAWN ARC PROCESS**
Gas protection

UNIQUE Linear Motor

3 m, ∅ 25 mm²
included
ARCPULL 200, 350 & COMBI ARCPULL

Adjustable

FULL CONTROL

Consumables for Gun
x2 059627
x1 059610

GYS POT ARCPULL 350 CAR BODY REPAIR

208 · 240V · 1~

350 A x1 MANUAL

PFC SR AD

082953

included

- Manual synergic gun 3 m, 25 mm²
- ALU RING BOX 1.5 mm (AlSpec + AlMg3 + AlMgSi) 059429
- ALU RING bag 2 mm (AlSpec x100) 065703
- Lifting rod 180 mm (x1) 082915

OPTIONS

Weld 810 for ARCPULL 350 037489



GYS POT ARCPULL 700 CAR BODY REPAIR

380 · 480V · 3~

680 A x1 MANUAL

SR IP 23

OPTIONS

Weld 910 for ARCPULL 700 070967



068315

included

- Manual synergic gun 5 m, 50 mm²
- Arc Pull Rivet Box 700
- Lifting rod 180 mm (x1) 082915
- Ground studs holder ∅ 6 (x1) 075368, ∅ 8 (x1) 075375, ∅ 10 (x1) 075382
- Threaded holder ∅ 5 (x1) 076174, ∅ 6 (x1) 068391
- Double earth clamps 700 A, 3 m, 50 mm² 068605
- ALU RING BOX 1.5 mm (AlSpec + AlMg3 + AlMgSi) 059429
- Gas protection (x1) 068346

MADE IN FRANCE 60974-1	50/60 Hz	I ₂ A	SYNERGIC	TECHNOLOGY		U ₂ V	A	kW	OK	OK	LxWxH cm / kg
				Acier/Steel	Alu						
GYS POT ARCPULL 350 CAR BODY REPAIR	208 · 240V	6 m	10 · 350	Manual + Digital Gun Motion Control	Power Factor Correction	20.4 · 34V	16	11.9	OK	OK	48 x 36 x 30 / 17.4
GYS POT ARCPULL 700 CAR BODY REPAIR	3x 400V 3x 480V	5 m	50 · 680	Manual + Digital Gun Motion Control	—	22 · 44V	20 A (D) 16 A (D)	47.8 kW 45.7 kW	OK	OK	60 x 43 x 46 / 27.8





GYSPOT ARC PULL 200, 350 & COMBI ACCESSORIES & CONSUMABLES

ACIER / STEEL / STAHL

x1 059634	x1 059641		x1 064065	x100 041561	x100 064034	x2 049000	x100 059603	x100 064607	x1 048157	x100 049383	x100 049413	x100 049420	x1 048164	x100 063969	x200 063990	x1 064041	x200 064003	x1 064058	x100 063976
STEEL STUDS BOX 200 & 350 059443	x1	x1				x1	x100		x1	x100	x100	x100							x1

ALU

x1 059634	x1 059641	x2 049000	x100 059573	x1 048157	x100 059580	x1 048164	x100 059597	x200 064010	x1 064041	x200 064027	x1 064058	x100 063983
ALU STUDS BOX 200 & 350 059436	x1	x1	x1	x100	x1	x100	x1	x100	x1	x100	x1	x100

	straight rings						twisted rings							
	Al-Special		AlMg3		AlMgSi		Al-Special		AlMg3 - x 50		AlMgSi - x 50			
box	n°1 1mm x100	n°4 1.5mm x100	n°8 2mm x100	n°2 1mm x100	n°5 1.5mm x100	n°3 1mm x100	n°6 1.5mm x100	n°1 1mm x50	n°4 1.5mm x50	n°2 1mm x50	n°5 1.5mm x50	n°3 1mm x50	n°6 1.5mm x50	
	059535	059559	065703	059498	059511	059450	059474	059542	059566	059504	059528	059467	059481	
box	ALU RING BOX 1 mm 059412		1mm x50		1mm x50		1mm x50		1mm x20		1mm x20		1mm x20	
box	ALU RING BOX 1.5 mm 059429		1.5mm x50		1.5mm x50		1.5mm x50		1.5mm x20		1.5mm x20		1.5mm x20	
sachet - bag	ALU RING BOX 2 mm 065703		2mm x100											

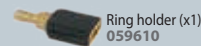

Earth clamp
Croco T400.70
043787



Double earth clamp
25 mm², 3 m, 350 A
070714

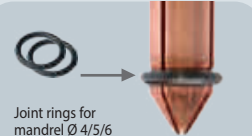

Joint rings for
mandrel Ø4/5/6
x2
060814

x1 064591	x1 070813	x1 059634	x1 059641	Ø2mm x1 064065	Ø4mm x2 049000	Ø5mm x1 048157	Ø6mm x1 048164	Ø7.1mm x1 064041	Ø8mm x1 064058	x1 070806	x1 070790	M4 x1 070752	M5 x1 070769	M6 x1 070776	M8 x1 070783	25 mm², 3 m, 350 A x1 070714
STUDS HOLDER BOX 350 064591	x1	x1	x1	x1	x1	x1	x1	x1	x1							x1
ARCPULL DIFFICULT ACCESS BOX 350 070813	x1	x1								x1	x1	x1	x1	x1	x1	x1

Difficult access :

To be used with :

x100 064607		x1 059634	x1 059641	x2 049000	x1 064683	x1 067721	x1 070738	x100 070745	x1 066151		
ARCPULL RIVET BOX 1 350 - 24kN 064584	x100	x1	x1	x1	x1	x1	x1				
ARCPULL RIVET BOX 2 350 - 50 kN 073388			x1	x1				x1	x100	x1	

GYSPOT ARC PULL 700 - ACCESSORIES & CONSUMABLES

x100 070745	x1 070738	x1 066151	x1 071377	x1 059641	x1 059610	x1 071384	x1	Ø6 x1 075368	Ø8 x1 075375	Ø10 x1 075382	Ø5 x1 076174	Ø6 x1 068391	Ø8 x1 068407
ARCPULL RIVET BOX 700 068452	x100	x1		x1	x1	x2	x1	x1	x1	x1			



FAST DENT PULLING

STEEL / ACIER / STAHL

EASY TOOL CONNECTION

for GYSPOT 39.02/04, PRO 230/400, EXPERT 230/400, COMBISPOT 230



051690

MANUSPOT =

050679



Tools set and support for DENT 600, 800, 1000, 1600, Workstation & Dentstation



EASYGUN 051317



MANULINER 050471

3 m Ø 35 mm2

PATENTS REGISTERED NUMBERS 001652108-0003 EUROPEAN TRADEMARK & DESIGN

4 positions 4 Positionen

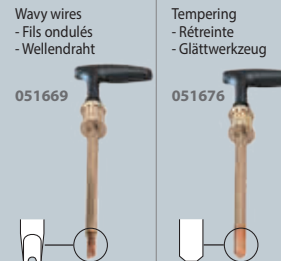
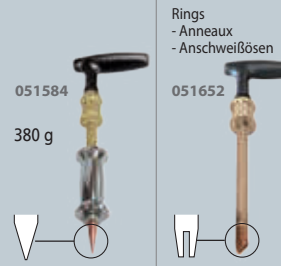
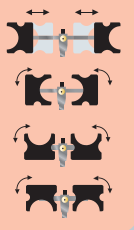

Box of 3 electrodes for accessories 050822

FAST & EASY

RINGMATIC 052154



included (x 50)



MANULINER/GUN

056831

PATENTS REGISTERED NUMBERS 001652108-0003 EUROPEAN TRADEMARK & DESIGN



Gun adapter - Adaptateur pistolet included 052499

Pads - Patins (x2) 060807

DENT AXE PULLER

080508

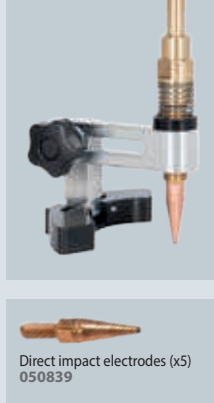

Direct impact electrodes (x5) 050839

QUICK SPOT AIR GUN V2

057340



LIGHT 920 g

AIR

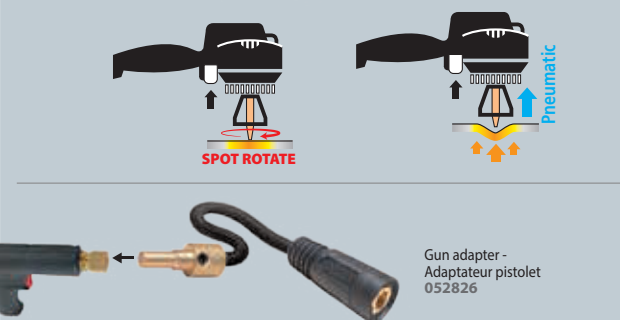

Gun adapter - Adaptateur pistolet 052826

MANU PULLER

079502



Included Alu 3 065178, Included Steel 079830, Included Alu 4 065185

ALU

ARC PULLER PREMIUM

065161



Included Alu 3 065178

Included Alu 4 065185

Pads - Patins (x2) 069008

ULTRA RESISTANT No deformation

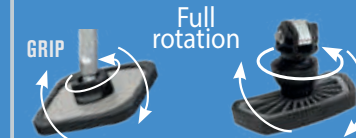

Multi positions

ARC PULLER PREMIUM PRO

072572



Pads - Patins (x4) 074958

Included Alu 3 065178, Included Alu 4 065185

ALU PULLER

4 positions

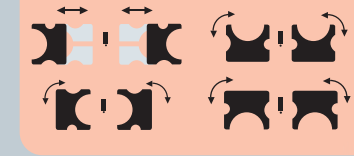

= 051003

Included Alu 1 050938, Included Alu 2 050945

Patins - Pads (x2) 060807

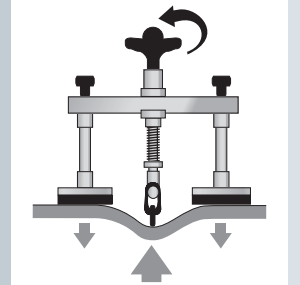

STRAIGHT LINE LAMP

- Lampe ligne droite - Dentline-laser

056770



FAST PULLING RINGS

- Anneaux de tirage rapide

058743 =

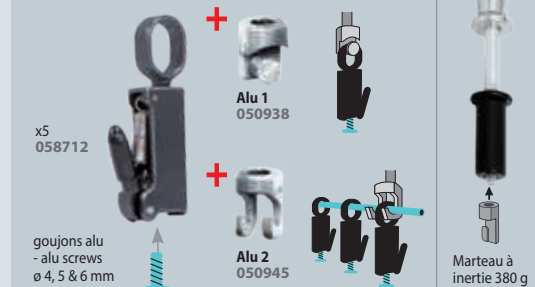

x5 058712

Alu 1 050938

Alu 2 050945

goujons alu - alu screws ø 4, 5 & 6 mm

ALU HAMMERS

- Marteaux alu

020986



Marteau à inertie 380 g 050051

Heat gun - Décapeur thermique - Heißluftpistole

I: 100/300°C (450 W), II: 300/650°C (1500 W), Air flow: 450 l/min



Affichage digital Digital display 066311

Gas hot air gun - Pistolet à air chaud autonome à gaz



Bouteille de gaz incluse, gas cylinder included 060777

Blow torch - Lampe à souder - Lötlampe



052741

Novacet+ (Butane/propane/propylene) 380ml/220g



040441

Brushes - Brosses - Bürsten - Brosses - Cepillos



044258

Thermal marking pencil - Crayon marqueur thermique



052765

Freezer spray - Spray refroidisseur



(x 12) 048898

Heat barrier spray - Spray barrière thermique



054325

Infrared Thermometer - Thermomètre infrarouge

-50 / +600°C, -58 / +1112°F



Adjustable emissivity: 0.10 ~ 1.00 079922

PULLING BARS

3 PRODUCT LINES

1 STANDARD

2 PREMIUM



3 PREMIUM PRO



STANDARD

Levelling lever
- Levier de débosselage
- Zughebel

050686
↓ 1.6 kg
⊗ 79 x 12 x 17 cm / 1.9 kg

PATENTS REGISTERED NUMBERS
001652108-0002
EUROPEAN TRADEMARK & DESIGN

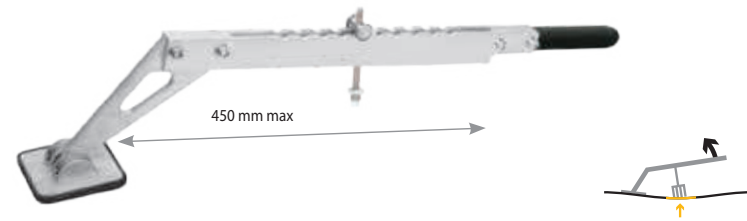

Double action levelling bar
- Barre de débosselage double action
- Zughebelbrücke

053564
↓ 2.5 kg
⊗ 77 x 12 x 13 cm / 3.2 kg

Licensed by
BETAG.Innovation

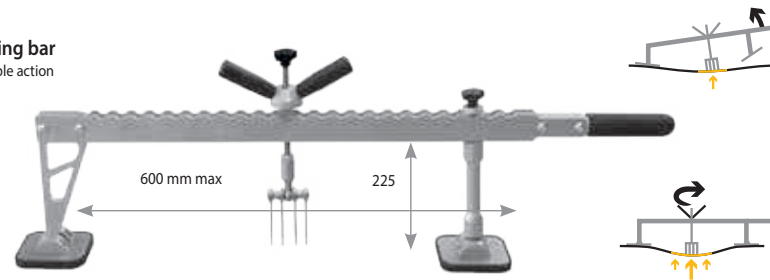

Levelling bar
- Barre de débosselage
- Zugbrücke

050693
↓ 3.4 kg
⊗ 87 x 17 x 19 cm / 4 kg

Licensed by
BETAG.Innovation

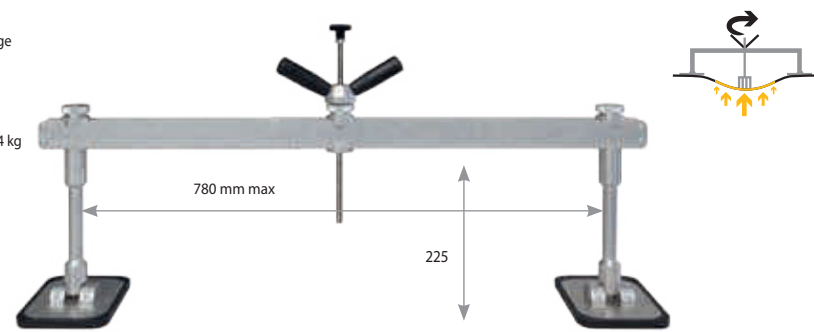

Reinforced scissoring bar
- Barre de tirage renforcée
- Scherenzugbrücke

050716
↓ 5.1 kg
⊗ 87 x 17 x 18 cm / 5.9 kg

PATENTS REGISTERED NUMBERS
001652108-0001
EUROPEAN TRADEMARK & DESIGN

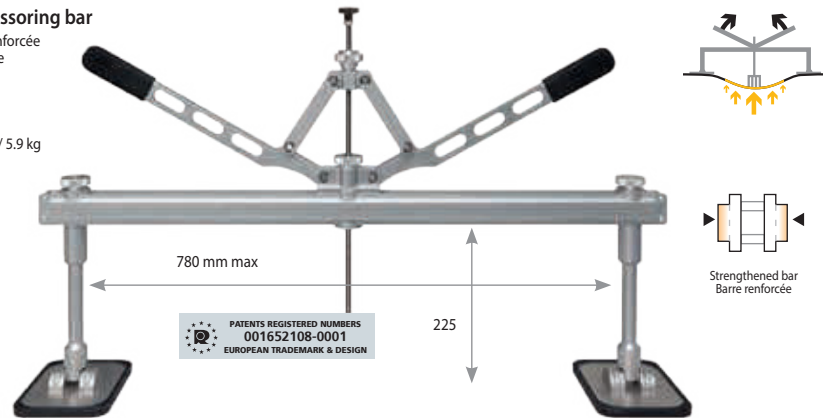

SLIDE & LOCK

Removable system : pads and pulling systems
Système amovible : patins et chariots de tirage

FEET



PULLING SYSTEM

only for 059313



LIGHTWEIGHT

Léger



GRIP 360

360° pads with grip
Patins à frein orientables à 360°



X-CROSS

Possibility of crossing the bars
Possibilité de croiser les barres

PREMIUM

Premium levelling lever
- Levier de débosselage Premium
- Premium Zughebel

059290
↓ 1.6 kg
⊗ 100 x 16 x 17 cm / 2.2 kg

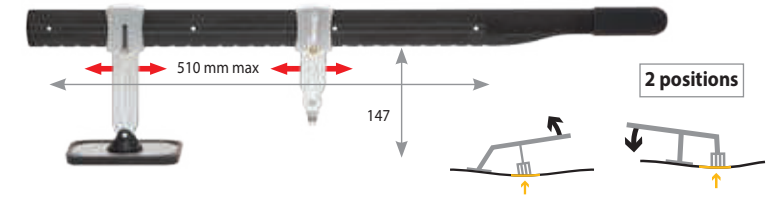

Premium levelling bar
- Barre de débosselage Premium
- Premium Zugbrücke

059306
↓ 2.8 kg
⊗ 79 x 30 x 13 cm / 3.2 kg

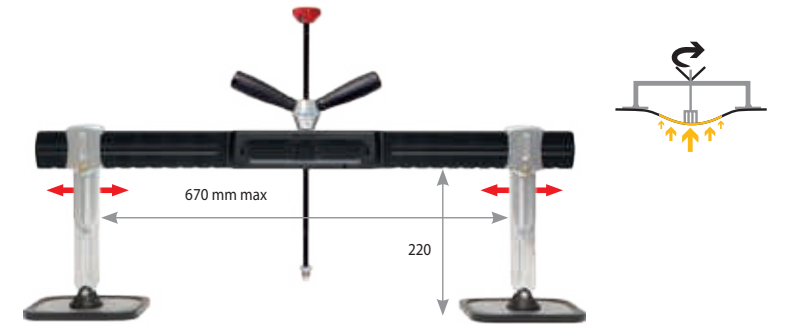

Premium scissoring bar
- Barre de tirage Premium
- Premium Scherenzugbrücke

058996
↓ 3.1 kg
⊗ 87 x 16 x 18 cm / 3.9 kg

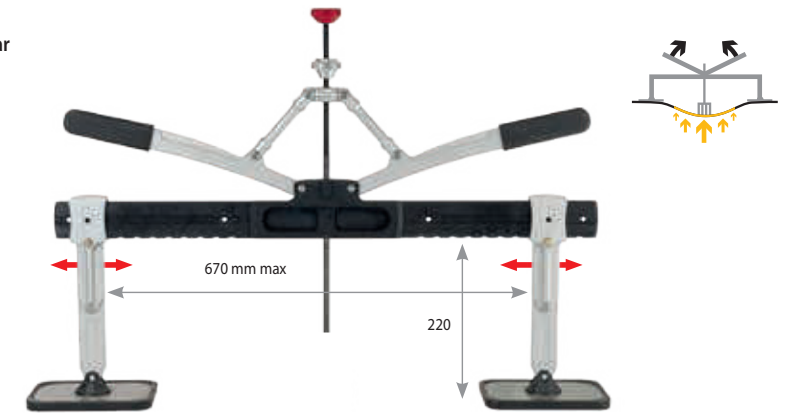

Premium 1200 scissoring bar
- Barre de tirage 1200 renforcée Premium
- Premium Scherenzugbrücke 1200

059313
↓ 5.6 kg
⊗ 127 x 26 x 9 cm / 6.2 kg

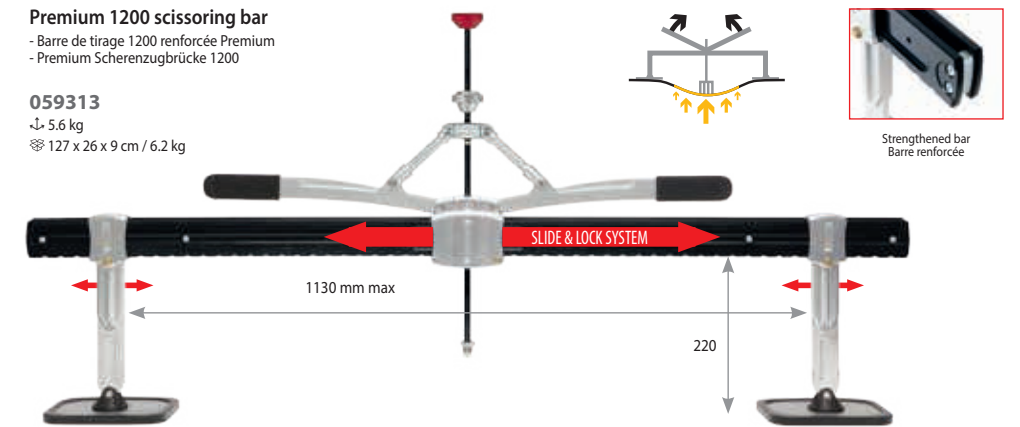

OPTIONS

Reinforced bar 1200 mm - Barre renforcée
051171

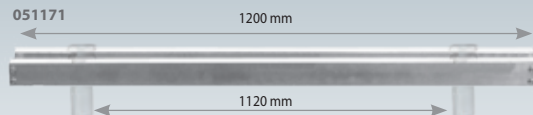

Fixing screw
058439

Double pads support
- Support double patin
- DoppelfüÙe
050723

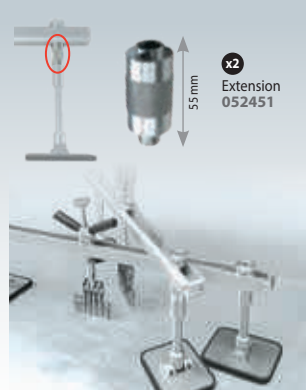

STANDARD

NEW



1 tooth hook
Ø M10 / M14
082021

STANDARD

PREMIUM (LONG FEET NEEDED)



4 tooth claw
Ø M10 / M14
049758



6 tooth claw
Ø M10 / M14
049734



8 tooth claw
Ø M10 / M14
049741



Ring-Pulling
068995

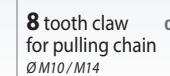

8 tooth claw for pulling chain
Ø M10 / M14
067745

PREMIUM



2 teeth hook
PREMIUM
Ø M14
059382



3 teeth hook
PREMIUM
Ø M14
059658

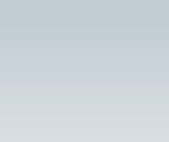
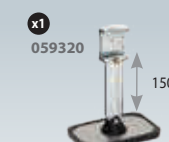

OPTIONS

SUPER ERGONOMIC



QUICK HOOK

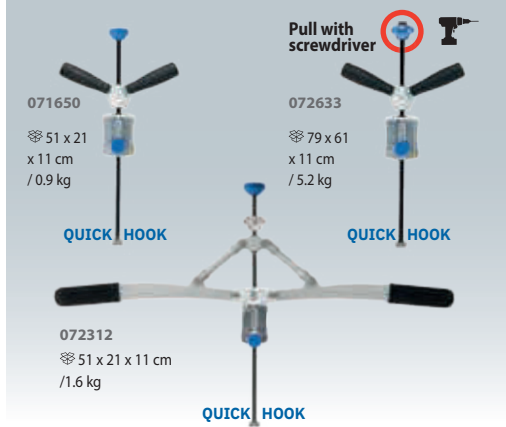
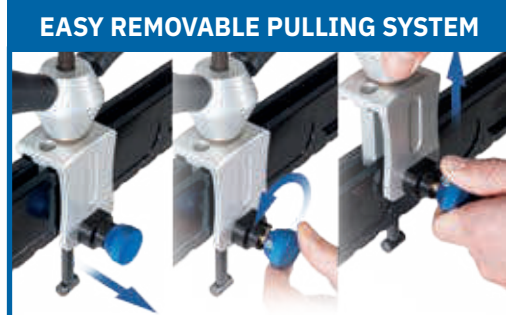
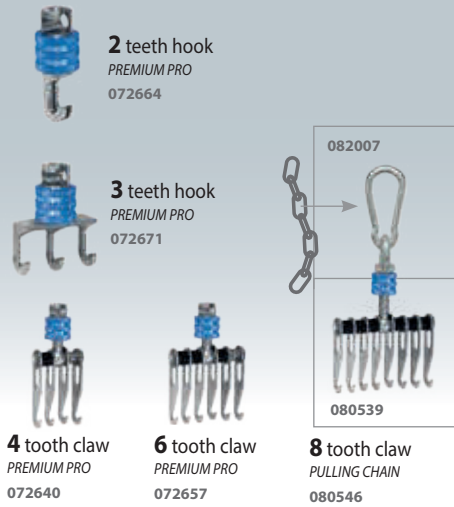

PREMIUM PRO

Premium Pro Levelling lever
- Levier de débousselage Premium Pro
- Premium Pro Zughebel

072619
↳ 1.6 kg
⊗ 87 x 17 x 18 cm / 2.3 kg

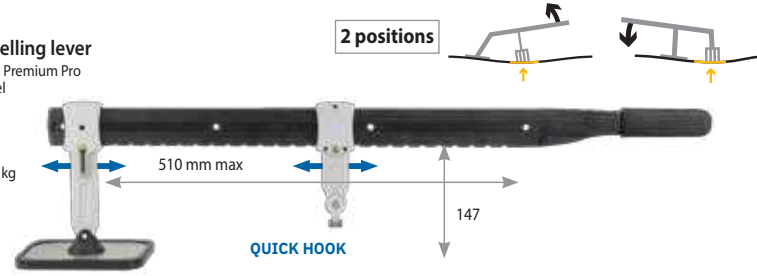

Premium Pro Levelling bar 900mm / Single feet
- Barre de débousselage Premium Pro 900 mm
- Premium Pro Zugbrücke 900 mm

071643
⊗ 120 x 26 x 8 cm / 4.4 kg
↳ 3.8 kg

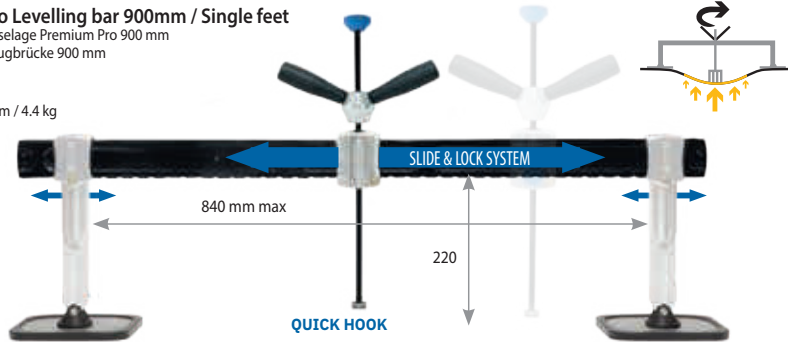

Premium Pro Levelling bar 900mm / Double feet
- Barre de débousselage Premium Pro 900 mm
- Premium Pro Zugbrücke 900 mm

080102
↳ 3.8 kg

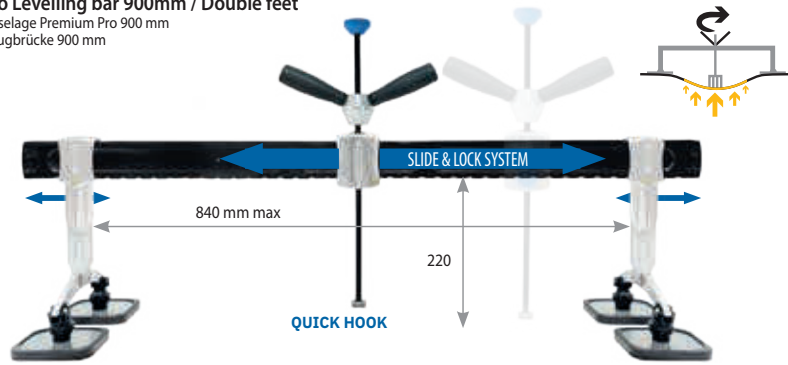

Premium Pro Scissoring bar 900mm
- Barre de tirage Premium Pro 900 mm
- Premium Pro Scherenzugbrücke 900 mm

072305
⊗ 103 x 30 x 13 cm / 5.2 kg
↳ 4.5 kg

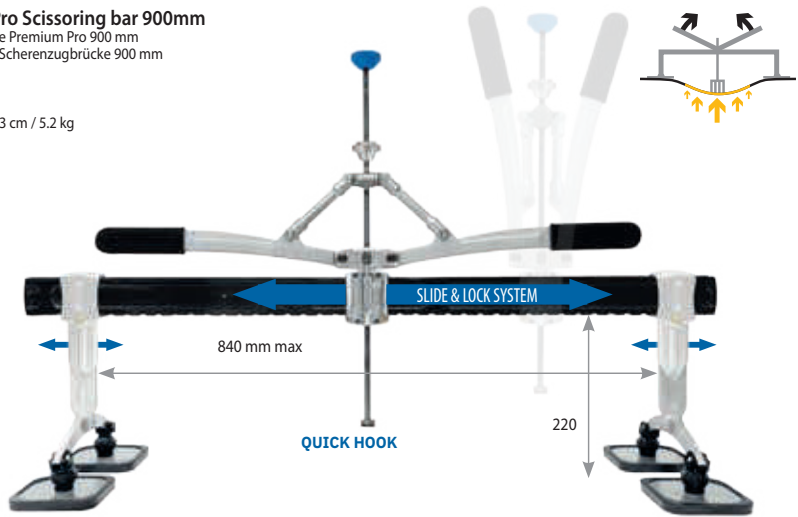

Premium Pro Scissoring bar 1150 mm
- Barre de tirage Premium Pro 1150 mm
- Premium Pro Scherenzugbrücke 1150 mm

072626
⊗ 124 x 7 x 7 cm / 3.1 kg



PREMIUM BAR SMART HAND

for Premium & Premium Pro
072480





DENT PULLING WORKSTATIONS

A COMPLETE SOLUTION
UNE SOLUTION COMPLÈTE
KOMPLETTLÖSUNGEN

Compatibility

SPOT	Dent 600	Dent 1000	Universal 800	Weld 810	Weld 910	Dent 1600	Dent 1600 WD	Dentstation Pro WD
26/27.02	✓	✓	✓	✓		✓		✓
34.02/04	✓	✓	✓	✓		✓		✓
39.02/04	✓	✓	✓	✓		✓		✓
PRO 230/400	✓	✓	✓	✓		✓		✓
EXPERT 230/400	✓	✓	✓	✓		✓		✓
ALU 66	✓	✓	✓					✓
ALU PRO FV	✓	✓	✓					✓
COMBI 230 E.PRO						✓		✓
ARCPULL 200/350				✓	✓	✓		✓
COMBI ARCPULL						✓		✓
ARCPULL 700					✓	✓		✓

Universal 800
↕ 60 x 48 x 83 cm
17,6 kg
↕ 79 x 39 x 18 cm
18,1 kg
051331

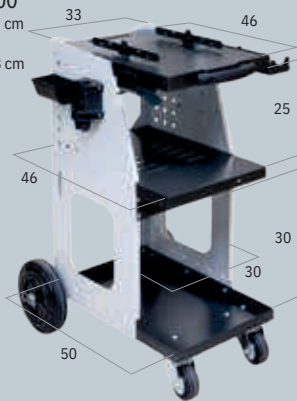

Weld 810
↕ 77 x 50 x 84 cm
20,1 kg
↕ 80 x 51 x 14 cm
21,6 kg
037489

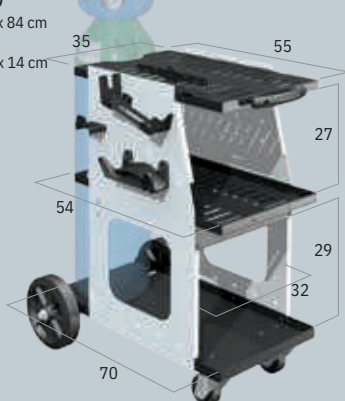

Weld 910
↕ 89 x 52 x 84 cm
25 kg
↕ 80 x 52 x 22 cm
27 kg
070967

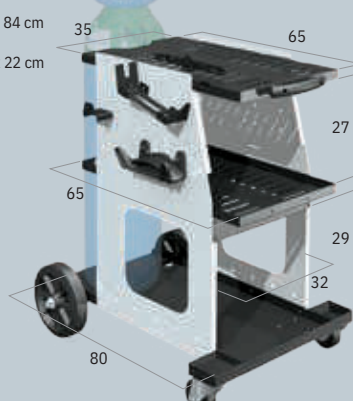

Dent 1600
↕ 70 x 69 x 161 cm
/ 35,8 kg
↕ 103 x 66 x 22 cm
/ 38,7 kg
072596

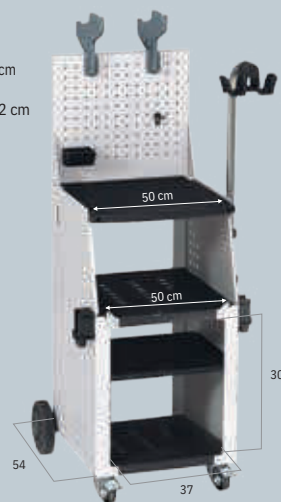

Dent 1600 WD
↕ 71 x 70 x 161 cm
/ 49,5 kg
↕ 103 x 66 x 22 cm
/ 52,4 kg
072169

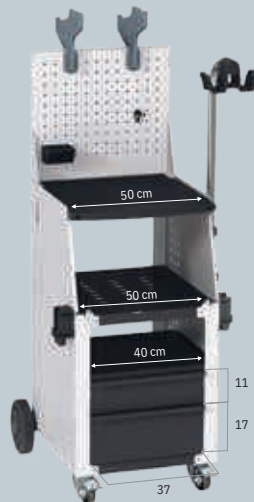

Dentstation Pro WD
↕ 90 x 71 x 161 cm
/ 65 kg
↕ 120 x 80 x 28 cm
/ 68,5 kg
072800



CHARIOTS / TROLLEYS

Dent 600
↕ 44 x 35 x 62 cm / 6,9 kg
↕ 60 x 39 x 14 cm / 7,4 kg
072831

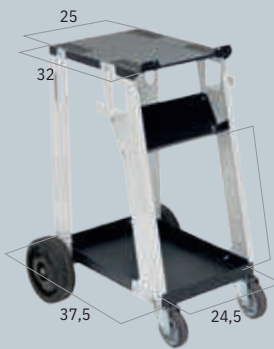

Dent 1000
↕ 44 x 35 x 98 cm / 9,3 kg
↕ 60 x 39 x 14 cm / 9,9 kg
072848



4 m³ support
for Dent 1600 /
1600 WD &
Dentstation Pro WD
059665



Cable support for
Spot 800, 1600
& Dentstation Pro WD
052284



Protection cover - Housse de protection
- Schutzhaube
for Universal 800
062733
for Spot 1600 & Dent 1600
048881
for Dentstation Pro
059870

EASYLINER



EASYLINER 39.02

EASYLINER PRO 230

PROLINER



PROLINER 39.02
PROLINER 39.04

PROLINER PRO 230
PROLINER PRO 400

PROLINER ALU PRO FV

PROLINER ARCPULL 200

STEEL / ACIER / STAHL



GYSPOT
(guns & consumables included)

STEEL / ACIER / STAHL



GYSPOT
(guns & consumables included)

ALU



GYSPOT
(guns & consumables included)

39.02
053618
☎ : 058521

PRO 230
072398

39.02
035775

PRO 230
035799

ALU PRO FV
035836

ARCPULL 200
065260



INCLUDED ACCESSORIES



DENT 1000
072848



Dent box easy
053632



Levelling bar double action
053564

INCLUDED ACCESSORIES



UNIVERSAL 800
051331
+ Cable support
052284



Dent box easy
050037



Levelling bar double action
053564



UNIVERSAL 800
051331
+ Cable support
052284



Alu puller
051003



Weld 810
037489
+ Cable support
052284



Arc puller premium
065161

SPEEDLINER STANDARD

COMPLETE
SYSTEM



PRO 230, 400 EXPERT 200, 230, 400 COMBI 230 E.PRO ARCPULL 200 + PRO 230, 400 ARCPULL 200 + EXPERT 200, 230, 400 ALU PRO FV

STEEL / ACIER / STAHL



GYSPT
(guns & consumables included)



GYSPT
(guns & consumables included)



GYSPT
(guns & consumables included)



GYSPT
(guns & consumables included)

PRO 230 074446	EXPERT 200 074460	COMBI 230 E PRO 074491	ARCPULL 200 + PRO 230 074507	ARCPULL 200 + EXPERT 200 074521	ALU PRO FV 074552
PRO 400 074453	EXPERT 230 074477		ARCPULL 200 + PRO 400 074514	ARCPULL 200 + EXPERT 230 074538	
	EXPERT 400 074484			ARCPULL 200 + EXPERT 400 074545	

INCLUDED ACCESSORIES

DENT 1600 072596	Cable support 052284	Levelling bar 850 mm 050693	052451
Magnetic earth 049666	Multihook heads 049758+049734	Levelling bar 050686	Ringmatic 052154
Alu puller 051003	Cable support 052284	Arc puller premium 065161	Cable support 052284 + 4 m support 059665
Stainless steel brush 044258	Alu Box 05 & 6 048195	Infrared Thermometer 079922	Hot air gun 650°C 066311

INCLUDED ACCESSORIES

DENT 1600 072596	Cable support 052284
Levelling bar 850 mm 050693	050693
Alu hammers 020986	Set of pencil punches with 6 teflon tips 052888
Multihook heads 049758	Alu puller 051003
Stainless steel brush 044258	Alu Box 05 & 6 048195
Infrared Thermometer 079922	Hot air gun 650°C 066311

Steel Speedliner without generator (excluded Ringmatic) : 035058

SPEEDLINER PREMIUM

★★★★
COMPLETE SYSTEM



PRO 230, 400



EXPERT 200, 230, 400



COMBI 230 E.PRO



ARCPULL 200
+ PRO 230, 400



ARCPULL 200
+ EXPERT 200, 230, 400



ARCPULL 200, 350

STEEL / ACIER / STAHL



GYSPOT
(guns & consumables included)



GYSPOT
(guns & consumables included)



GYSPOT
(guns & consumables included)

ALU



GYSPOT
(guns & consumables included)

PRO 230 073883	EXPERT 200 073906	COMBI 230 E PRO 073968	COMBI ARCPULL 074569	ARCPULL 200 + PRO 230 073975	ARCPULL 200 + EXPERT 200 073913	ARCPULL 200 073999	ARCPULL 350 083042
PRO 400 073890	EXPERT 230 073920			ARCPULL 200 + PRO 400 073982	ARCPULL 200 + EXPERT 230 073937	077317 (without HOT AIR GUN)	
	EXPERT 400 073944				ARCPULL 200 + EXPERT 400 073951		

INCLUDED ACCESSORIES

INCLUDED ACCESSORIES

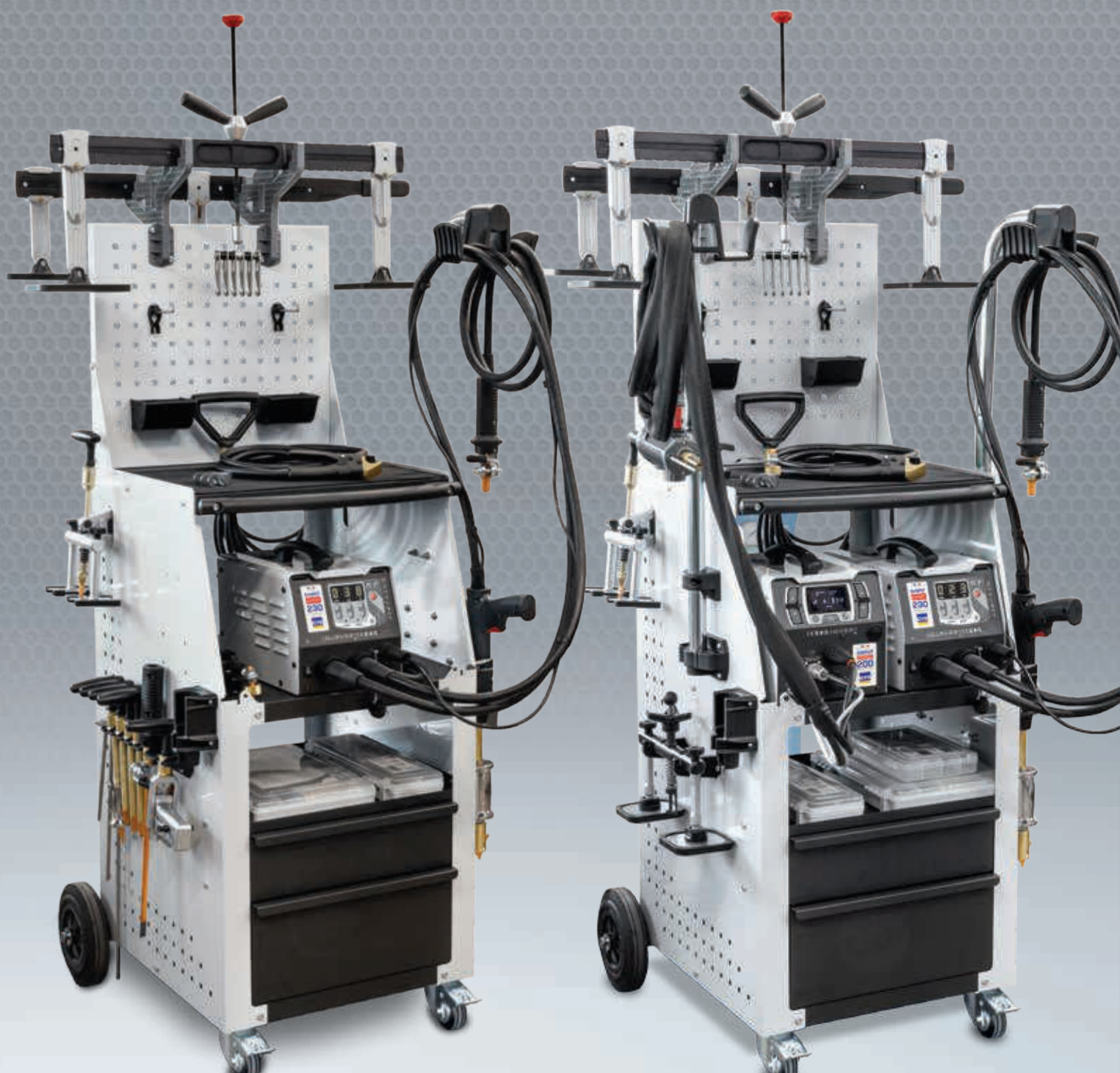

SPEEDLINER PREMIUM PRO



PRO 230, 400



EXPERT 200, 400
+ ARCPULL 200, 350



COMBI ARCPULL



ARCPULL 200, 350

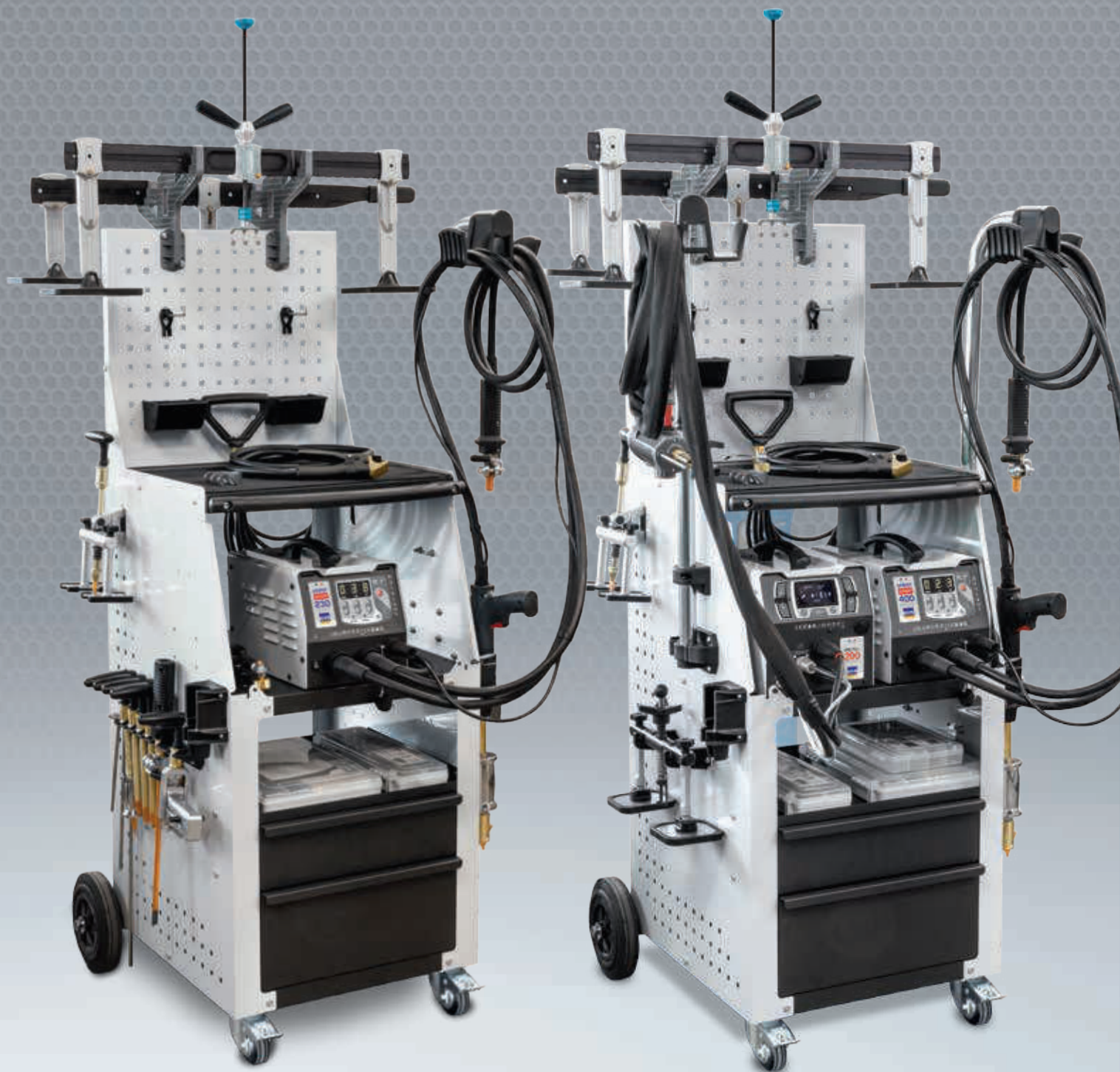

STEEL / ACIER / STAHL



GYSPOT
(guns & consumables included)

ALU + STEEL / ACIER / STAHL



GYSPOT
(guns & consumables included)



GYSPOT
(guns & consumables included)

ALU



GYSPOT
(guns & consumables included)

EXPERT 230 080201	EXPERT 400 080218	EXPERT 400 + ARCPULL 200 080232	EXPERT 400 + ARCPULL 350 083028	COMBI ARCPULL 080225	ARCPULL 200 080256	ARCPULL 350 083035
		EXPERT 200 + ARCPULL 200 080553				

INCLUDED ACCESSORIES



Dent 1600 WD
072169



Premium Pro levelling bar 900 mm
071643



Premium Pro levelling bar
072619



Ringmatic
052154



Manuspot
050679



Premium Pro teeth hook
072671 + 072664 + 072640



Manual pulling handle
057289

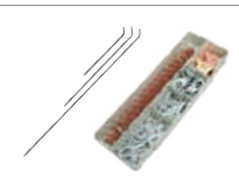

3 lifting rods
050792
Dent box consumables
051515



Magnetic earth
049666



Cable support
052284
4 m support
059665
Arc Puller Premium Pro
072572

INCLUDED ACCESSORIES



Dent 1600 WD
072169



Alu Ring Box 1 mm



072664



4 m support
059665



Premium Pro levelling bar 900 mm
071643



Set of pencil punches with 6
teflon tips
052888



Arc Puller Premium Pro
072572



Alu hammers
020986



Infrared Thermometer
079922
Hot air gun 650°C
066311



Stainless steel brush
044258



3 lifting rods
050792

DENTSTATION STANDARD



39.02, 39.04 PRO 230, 400 EXPERT 200, 230, 400 COMBI 230 E.PRO ARCPULL 200 + PRO 230, 400 ARCPULL 200 + EXPERT 200, 230, 400

COMPLETE SYSTEM

STEEL / ACIER / STAHL



GYSPOT
(guns & consumables included)

ALU + STEEL / ACIER / STAHL



GYSPOT
(guns & consumables included)



GYSPOT
(guns & consumables included)

39.02	PRO 230	EXPERT 200	COMBI 230 E PRO	ARCPULL 200 + PRO 230	ARCPULL 200 + EXPERT 200
078161	078208	078321	078529	078222	078338
39.04	PRO 400	EXPERT 230		ARCPULL 200 + PRO 400	ARCPULL 200 + EXPERT 230
078185	078260	078369		078284	078384
		EXPERT 400 078444			ARCPULL 200 + EXPERT 400 078468



INCLUDED ACCESSORIES

<p>Dentstation Pro WD 072800 Fixing kit 051362</p>	<p>Double pads 050723</p>	<p>Levelling bar 850 mm 050693</p>	<p>Scissoring bar 050716</p>
<p>Magnetic earth 049666</p>	<p>Multihook heads 049758 +049734 +049741</p>	<p>Levelling lever 050686</p>	<p>Strengthened bar 1200 mm 051171 Extensions (x2) 052451</p>
<p>Fast pulling rings (x5) 058712 + Alu puller 051003</p>	<p>Cable support 052284</p>	<p>Arc puller premium 065161</p>	<p>Cable support 052284 + 4 m support 059665 + Flanges (x 2) 062146</p>

DENTSTATION PREMIUM



PRO 230, 400



EXPERT 200, 230, 400



COMBI 230 E.PRO
COMBI ARCPULL



ARCPULL 200
+ PRO 230, 400



ARCPULL 200
+ EXPERT 200, 230, 400

★ ★ ★ ★
COMPLETE
SYSTEM

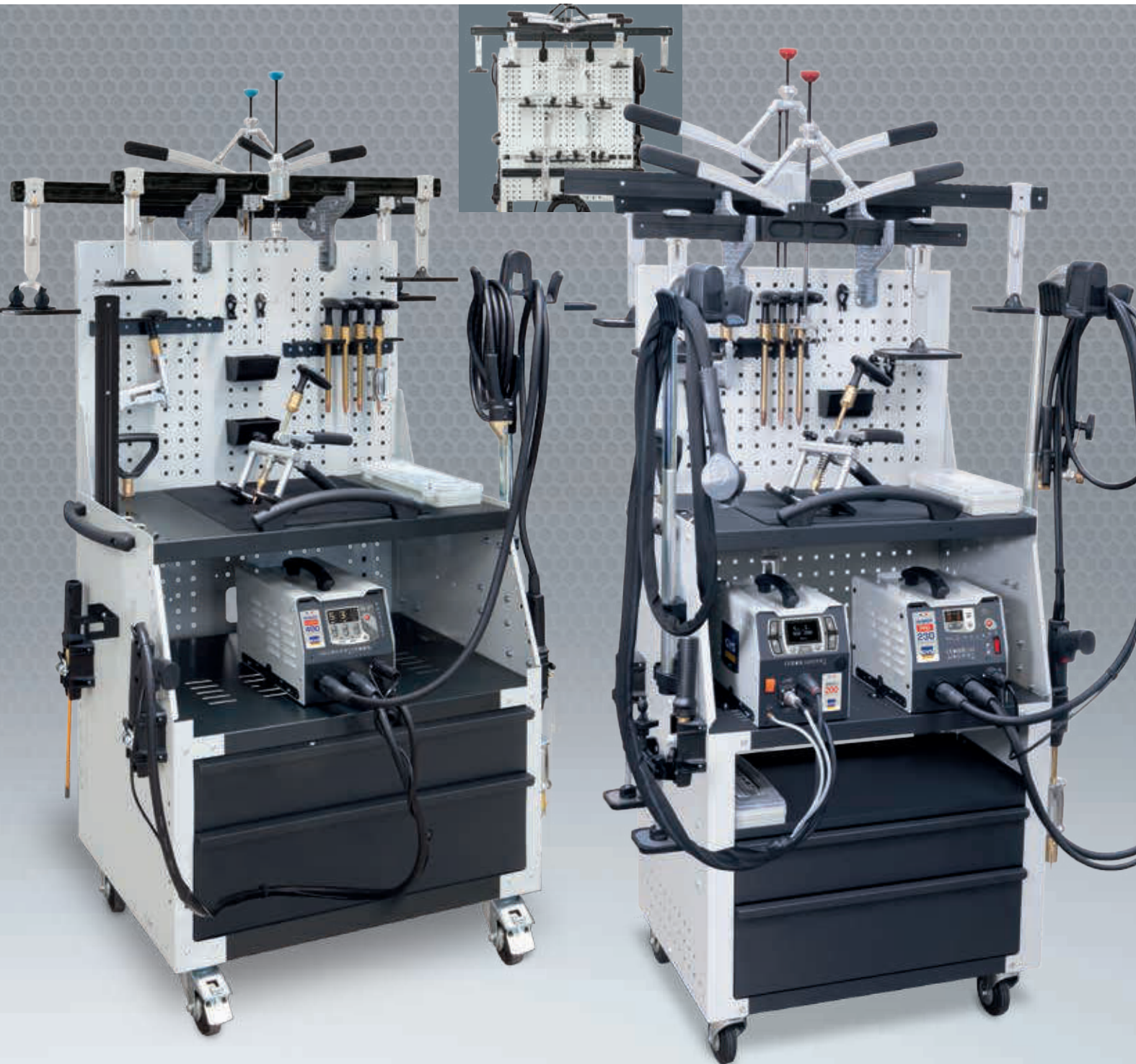

STEEL / ACIER / STAHL



GYSPOT
(guns & consumables included)

ALU + STEEL / ACIER / STAHL



GYSPOT
(guns & consumables included)



GYSPOT
(guns & consumables included)

PRO 230 078239	EXPERT 200 078345	COMBI 230 E PRO 078543	COMBI ARCPULL 078567	ARCPULL 200 + PRO 230 078253	ARCPULL 200 + EXPERT 200 078352
PRO 400 078291	EXPERT 230 078406			ARCPULL 200 + PRO 400 078314	ARCPULL 200 + EXPERT 230 078420
	EXPERT 400 078482				ARCPULL 200 + EXPERT 400 078505

INCLUDED ACCESSORIES



Dentstation Pro WD
072800
Fixing kit
051362



Manuspot
050679



Premium levelling bar 720 mm
059306



Premium levelling lever
059290



Hook head
049734
+ 059658
+ 059382



Premium scissoring bar 720 mm
058996



Premium scissoring bar 1200 mm
059313



Magnetic earth
049666



Premium double pads support 150 mm (x2)
059351
+ 220 mm (x2)
059375

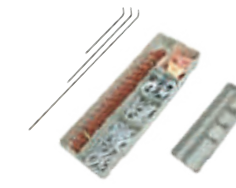

Dent box consumables
051515
3 lifting rods
050792
Empty box 320x113mm



Manual pulling handle
057289



Ringmatic
052154



Fast pulling rings (x5)
058712
Alu puller
051003
Cable support
052284



Cable support
052284
4 m² support
059665
Flanges (x 2)
062146
Arc puller premium
065161



Arc puller premium
065161



Cable support
052284
4 m² support
059665
Flanges (x 2)
062146

DENTSTATION PREMIUM PRO



EXPERT 230, 400



COMBI ARCPULL



EXPERT 400 + ARCPULL 200, 350



ARCPULL 200, 350

STEEL / ACIER / STAHL



1 BOX GYS SPOT (guns & consumables included)

ALU + STEEL / ACIER / STAHL



1 BOX GYS SPOT (guns & consumables included)

ALU



1 BOX GYS SPOT (guns & consumables included)

EXPERT 230	EXPERT 400	EXPERT 400 + ARCPULL 200	EXPERT 400 + ARCPULL 350	COMBI ARCPULL	ARCPULL 200	ARCPULL 350
080133	080140	080164	083004	080157	080461	083011

INCLUDED ACCESSORIES



1 BOX Dentstation Pro WD 072800



Premium pro levelling bar 900mm 071643



Premium pro levelling lever 072619
Premium pro bar 1184 mm 072626



Manuspot 050679

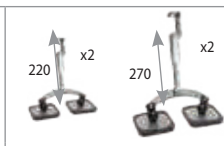

x2 220 x2 270
(x2) 059375 + (x2) 072688

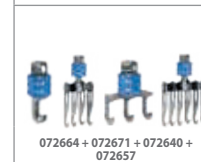

072664 + 072671 + 072640 + 072657



071650 + 072312

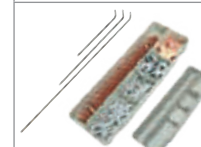

Dent box consumables 051515
3 lifting rods 050792
Empty box 320x113mm



Magnetic earth 049566
Ringmatic 052154
Manual pulling handle 057289

1 BOX STEEL ACCESSORIES PACK V2 080126

INCLUDED ACCESSORIES



1 BOX Dentstation Pro WD 072800



Premium pro levelling bar 900mm 071643 (x2) 059375



072664 + 072640 + 071650 Alu Ring Box 1 mm 059412



Alu hammers 020986



Arc Puller Premium Pro 072572



Set of pencil punches with 6 teflon tips 052888

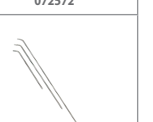

3 lifting rods 050792



Stainless steel brush 044258



Infrared Thermometer 079922



Hot air gun 650°C 066311



4 m³ support 059665

1 BOX ARCPULL ACCESSORIES PACK 080485

+



Cable support 052284



4 m³ support 059665



Arc Puller Premium Pro 072572

1 BOX ALU ACCESSORIES PACK 073838





PULLING SYSTEMS

AIRFIX DRAW ALIGNER	38
DRAW ALIGNER	40
FRAME STRAIGHTENING	42



DRAW ALIGNER



Designed for

- ★ TIME SAVING
- ★ DURABILITY
- ★ MAXIMUM GRIP

4 pads :
**Seal protection,
Perfect stability**

4 patins : protection du joint, stabilité parfaite
4 Pads: Dichtungsschutz, perfekte Stabilität
4 piedini: protezione sigillata, perfetta stabilità

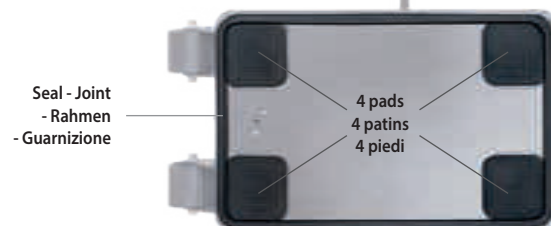
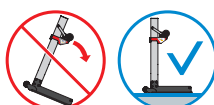

Quick & easy set up



Compact & light
31 kg

No tools

Ground anchor by suction

Fast installation

Ancrage au sol par aspiration : installation rapide
Verankerung durch Vakuumbildung – schnell einsatzfähig
Ancoraggio a terra: installazione rapida

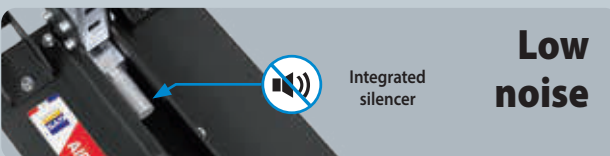
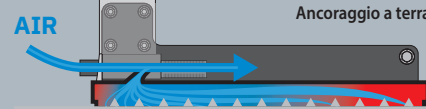

Low noise

Integrated silencer

Smart maintenance



- No glue
- No tools

Pads - Patins (x2)
069008

Plate seal - Joint de plaque
079571



AIRFIX DRAW ALIGNER

Air 5-8 bars

077379

080669

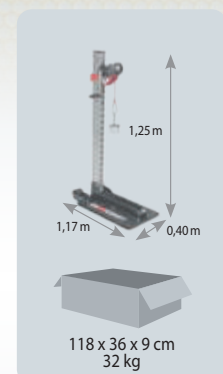

350 kg Uniform pulling force

Force de tirage uniforme
Gleichmäßige Zugkraft
Forza di spinta uniforme

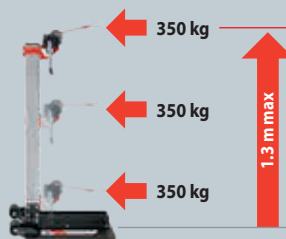

Precision

All directions

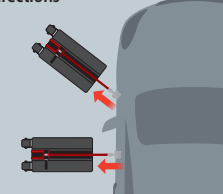

Down-pulling

Rocker panel
- Bas de caisse
- Schweller
- Sottoporta

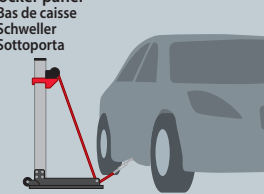

Up-pulling

Upper-parts
- Parties hautes
- Oberteile

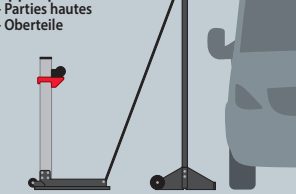

Options

Welding sheets kit
- Kit plaques à souder
083493

NEW



- 25 mm (x1 included) x5 083509
- 38 mm (x1 included) x5 083516
- 50 mm (x1 included) x5 083523
- 75 mm (x1 included) x5 083530

12 tooth claw
- Griffe 12 dents
082229

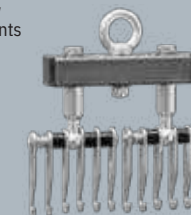

Option

XL mast for Airfix Draw Aligner
- Mât XL - XL-Mast

083714

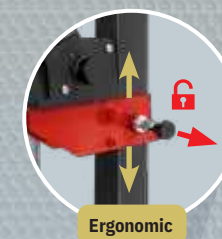

Ergonomic

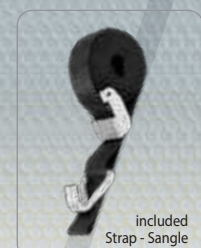

included Strap - Sangle

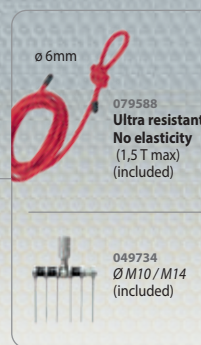

079588
Ultra resistant
No elasticity
(1,5 T max)
(included)



049734
Ø M10 / M14
(included)

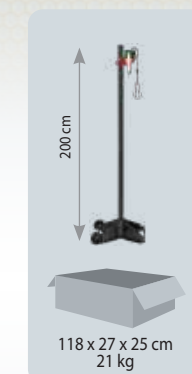

1,3 m

NEW
07/2024



PULLING SYSTEMS

**DRAW ALIGNER**

Draw aligner - Équerre de tirage - Schnellausbeul-Richtausleger
052475

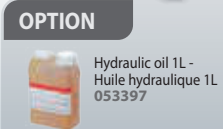
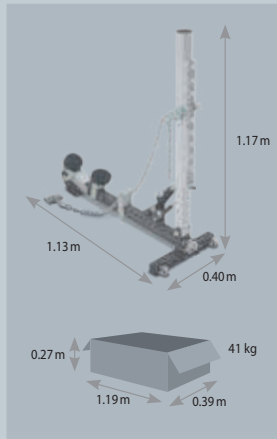
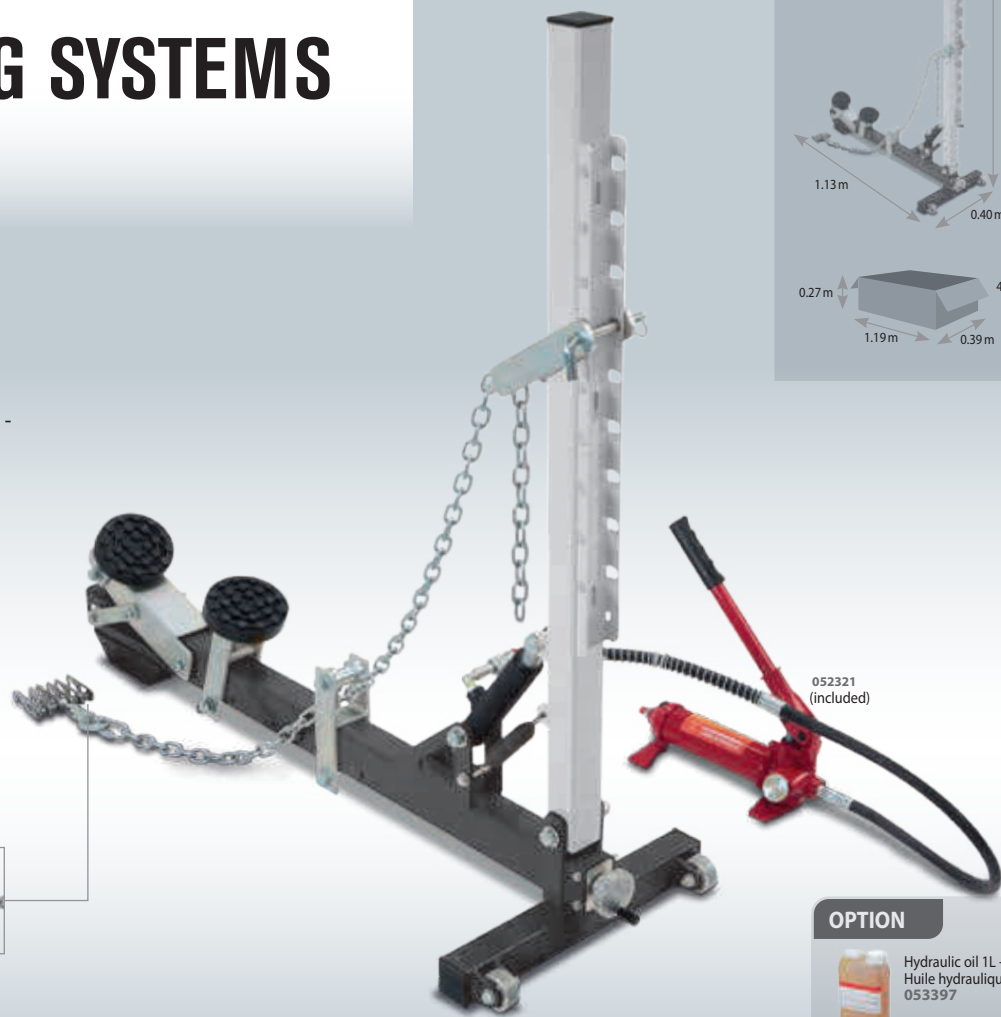
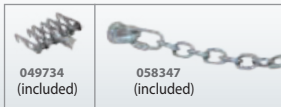
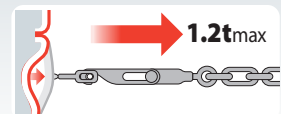
**INCLUDED**

Wedge for rocker panel - Cône pour bas de caisse

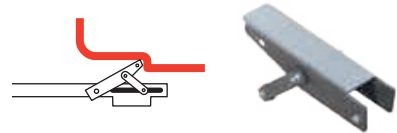

Pads kit for rocker panel - Kit patins pour bas de caisse

**OPTION**

Rocker panel arms for draw aligner - Bras de bas de caisse - Abstütztraverse für Richtausleger

052581

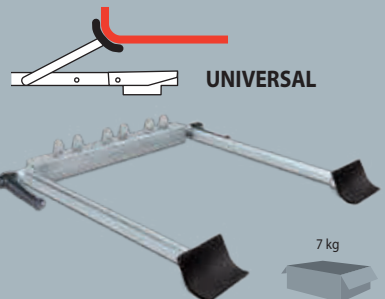
**OPTION**

12 tooth claw for pulling chain 082229

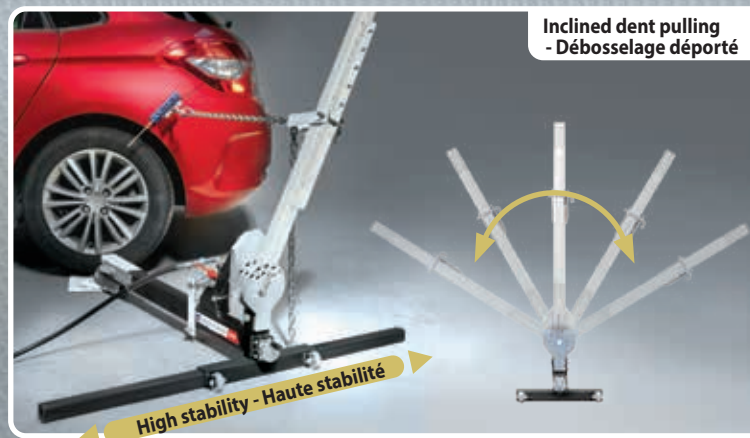
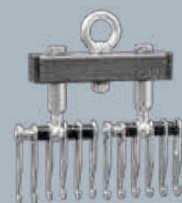
**DRAW ALIGNER PRO**

069244

**INCLUDED**

Plate under the wheel - Cône sous roue
Compatible with Draw Aligner & Draw Aligner Pro 076693



Wedge for rocker panel - Cône pour bas de caisse

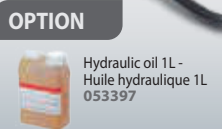
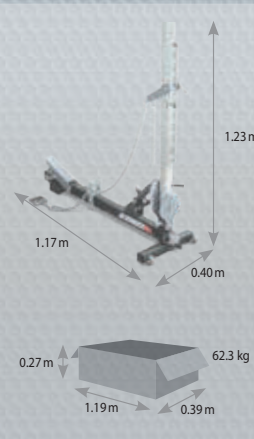
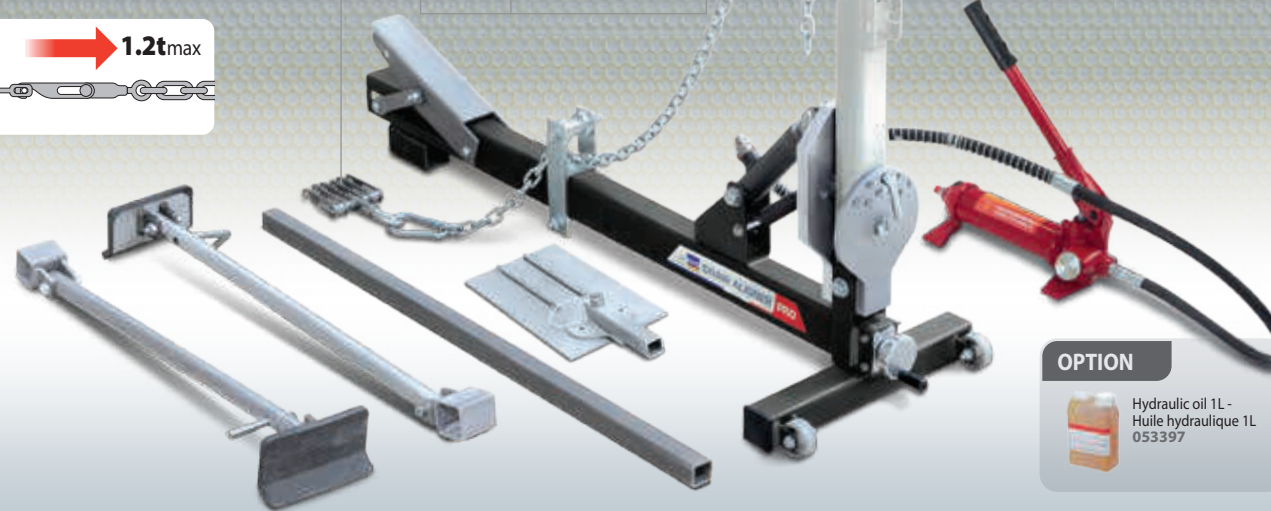
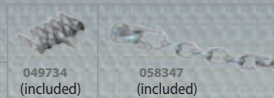
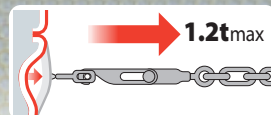
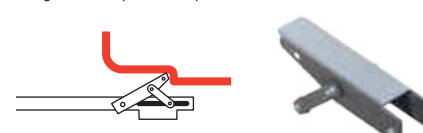

Rocker panel arms and stabilisation bar - Kit bras de bas de caisse et barre de stabilisation

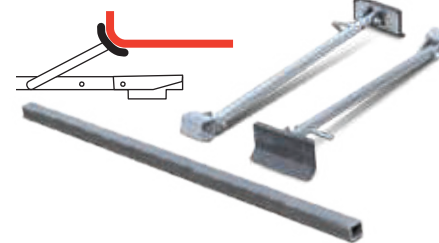
**OPTIONS**

Pads kit for rocker panel - Kit patins pour bas de caisse 071278

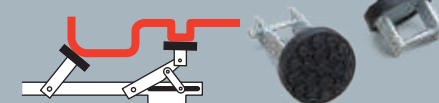

ELECTRO POWER - Zug-Druckpresse

with accessories : 057425



INCLUDED

Accessories kit : 425x620x150 mm
Accessories kit
Total weight: 20 kg



057418

Standard kit : 425x620x210 mm
Standard kit
Total weight: 18 kg



057401

Li-Ion battery 058514

OPTION

Pince écarteur 079496

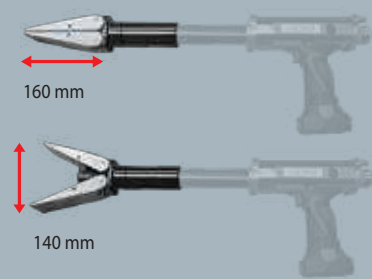

160 mm

140 mm

-PULLING POWER: 5 Ton.
-PUSHING POWER: 5 Ton.
-PISTON
-STROKE: 130 mm

Spreading / Estensione

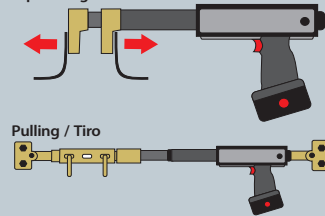

Pressing / Compressione

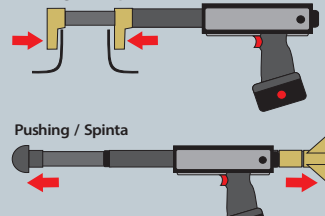

Pulling / Tiro

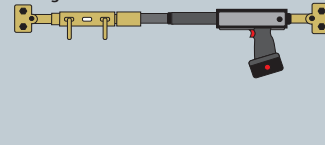

Pushing / Spinta

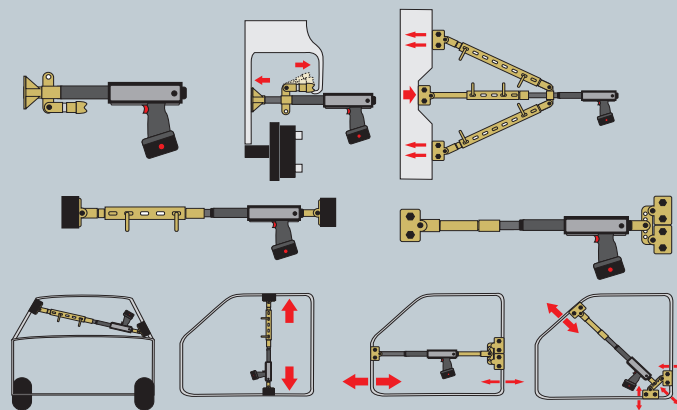
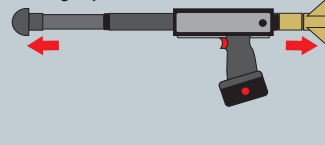

ANCHOR BAR - Barre d'ancrage - Türspanner

MADE IN TAIWAN

053045



053052



INERTIA HAMMER KIT - Kit marteau à inertie - Ausziehhammer kit

Inertia hammer kit
- Kit marteau à inertie
- Ausziehhammer kit
051928



POWER-PULLER 4T

059740

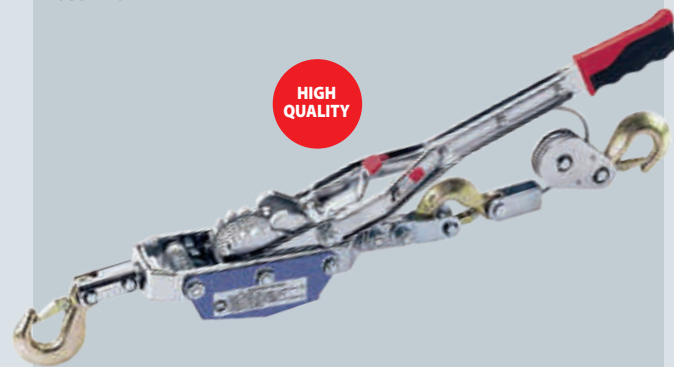

HYDRAULIC CYLINDER KIT - Coffret vérin hydraulique - Hydraulischer Drucksatz

MADE IN CHINA

OPTION



Hydraulic oil 1L - Huile hydraulique 1L 053397

BASIC 4T
052345



BASIC 10T
052338

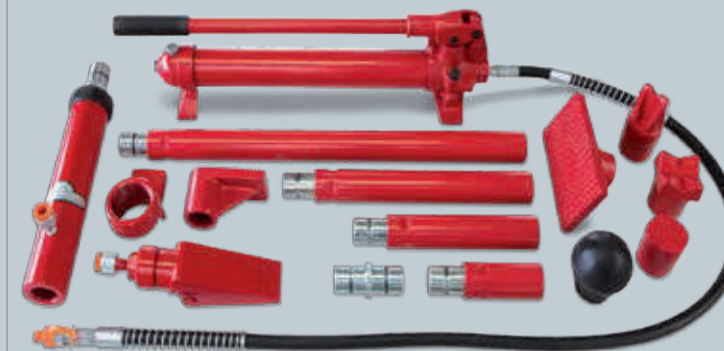

PRO 4T
057432



PRO 10T
057449



MEASURING TOOLS - Mesures - Vermessung

BODYMETER, Mechanical measurements

052130



GYSMETER, Electronic measurements

052093

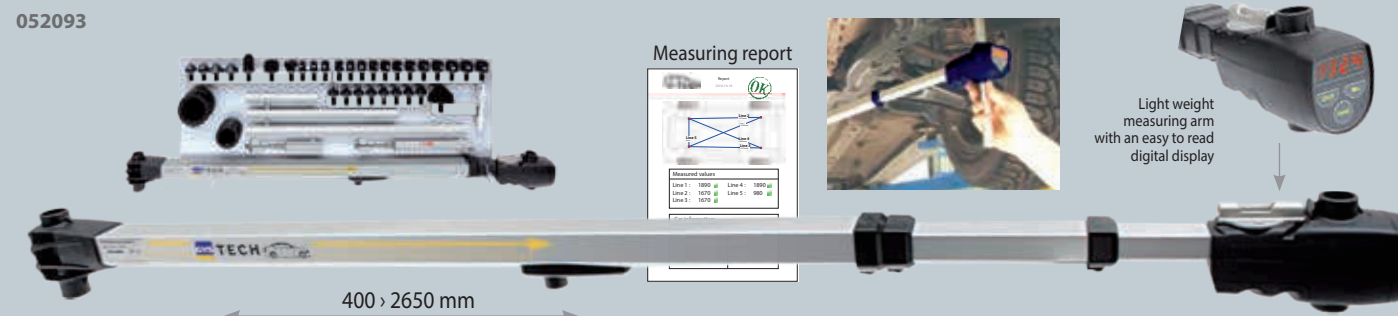

Measuring report

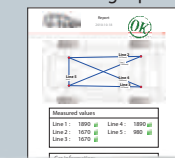

Light weight measuring arm with an easy to read digital display

SWIVEL CLAMP
- Pince pivotante



PULL CLAMPS - Pincas de tirage - Ziehwerkzeuge

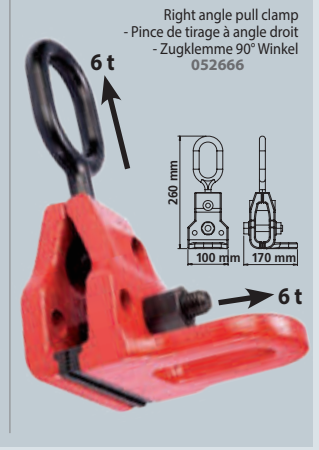
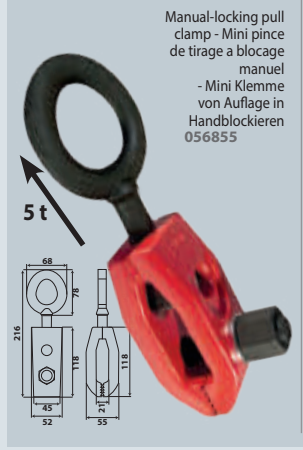

PULL HOOK - Crochet de tirage - Ziehwerkzeuge

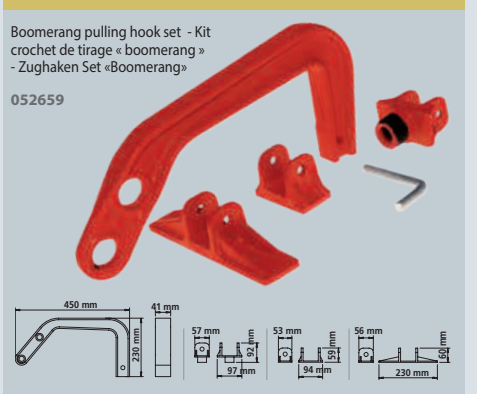

ARCH HOOKS - Passage de roue

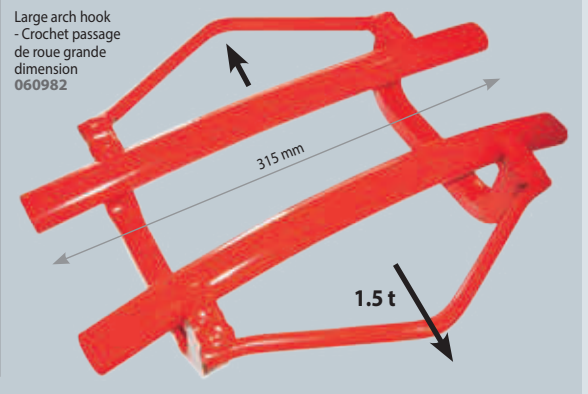
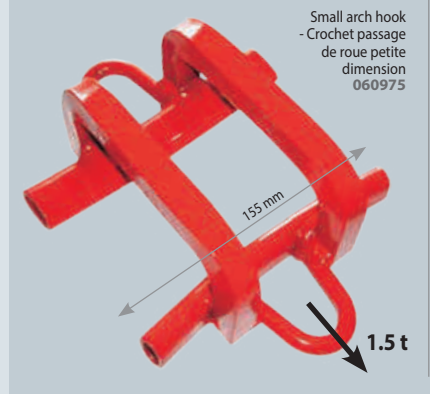

PULLING CHAIN - Chaînes de tirage - Ziehwerkzeuge

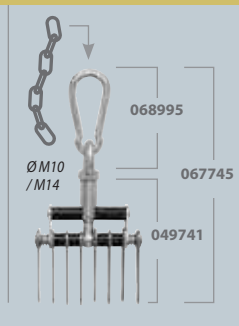
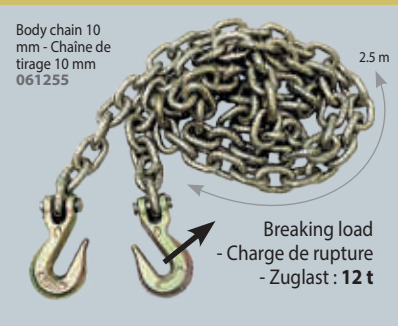
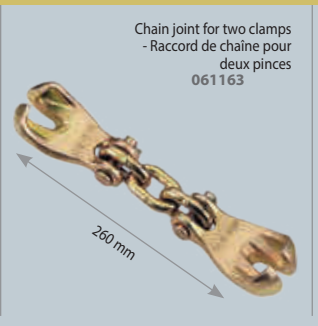
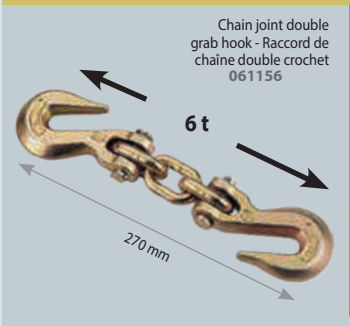

WIDE PULL CLAMPS - Pincas de tirage larges

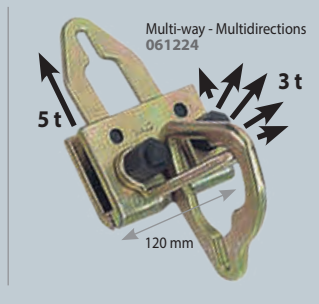
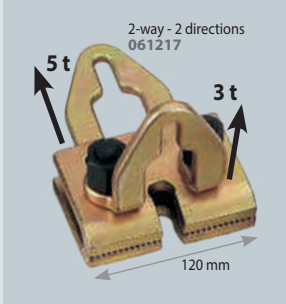

SMALL PULL CLAMPS - Pincas de tirage faible largeur

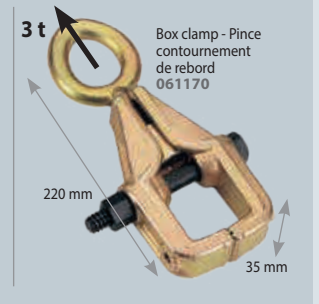
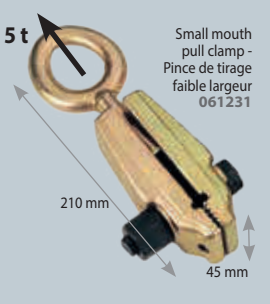
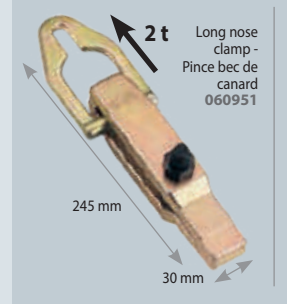

MULTIPLE PULL CLAMP
- Pince de tirage multiple

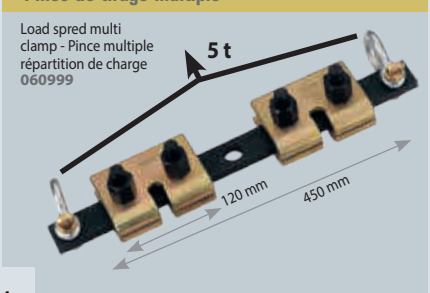

45 MM SCISSORS CLAMP
- Pince ciseaux largeur 45 mm

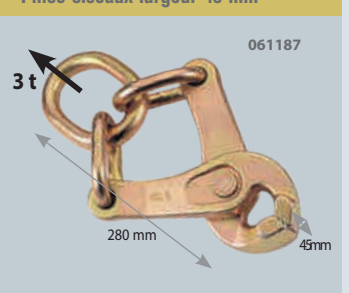

90 DEGREE CORNER CLAMP
- Pince de tirage pour angle 90°



C TYPE CLAMP
- Pince de tirage type C



SMART SATELLITE - Satellite intelligent- Satellite Komplett-Kit

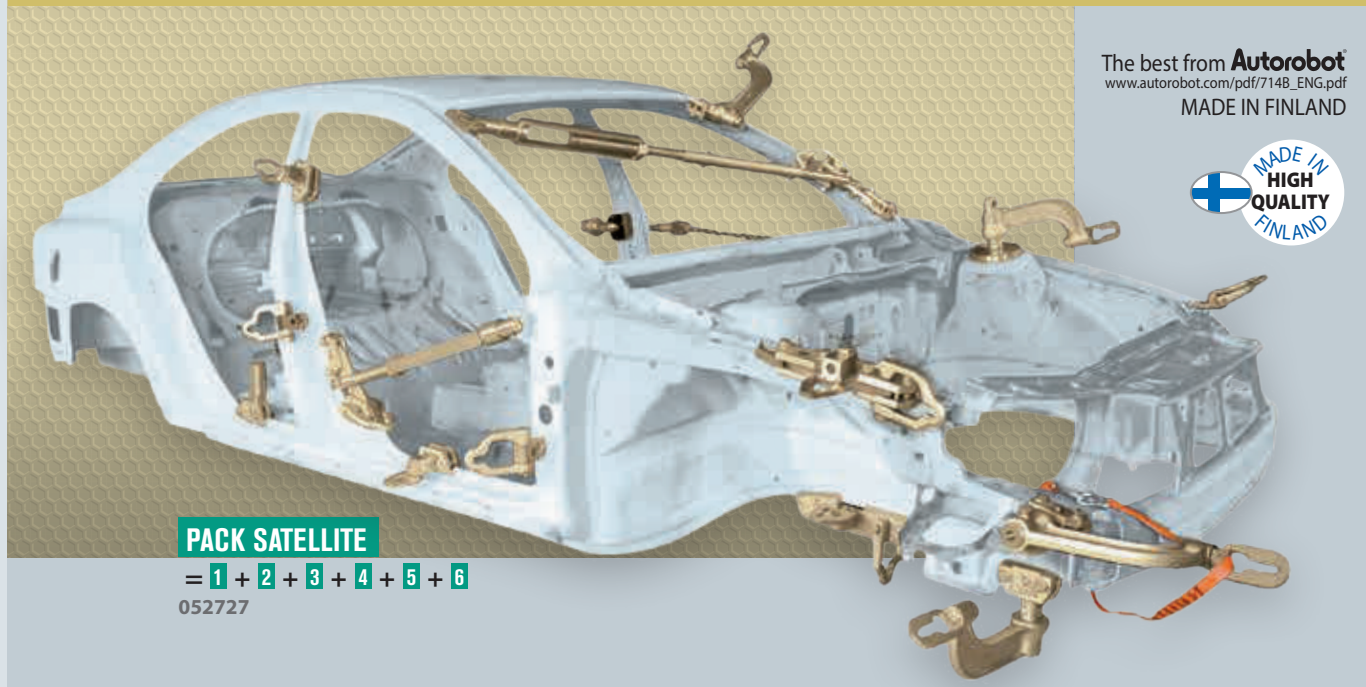

The best from **Autorobot**
www.autorobot.com/pdf/7148_ENG.pdf
MADE IN FINLAND



PACK SATELLITE
= 1 + 2 + 3 + 4 + 5 + 6
052727

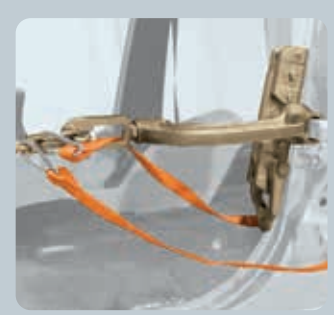

PINCE DE TIRAGE MULTI-USAGE
- Versatile pulling clamp
- Multifunktions-Zugklemme

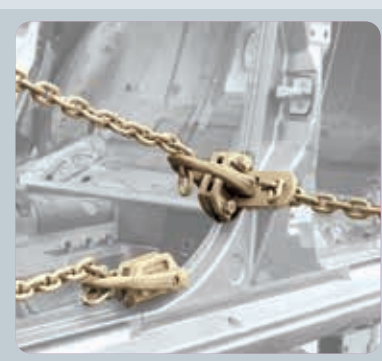

WELDING SHEETS KIT WITH CLAMP
- Kit plaques à souder et pince



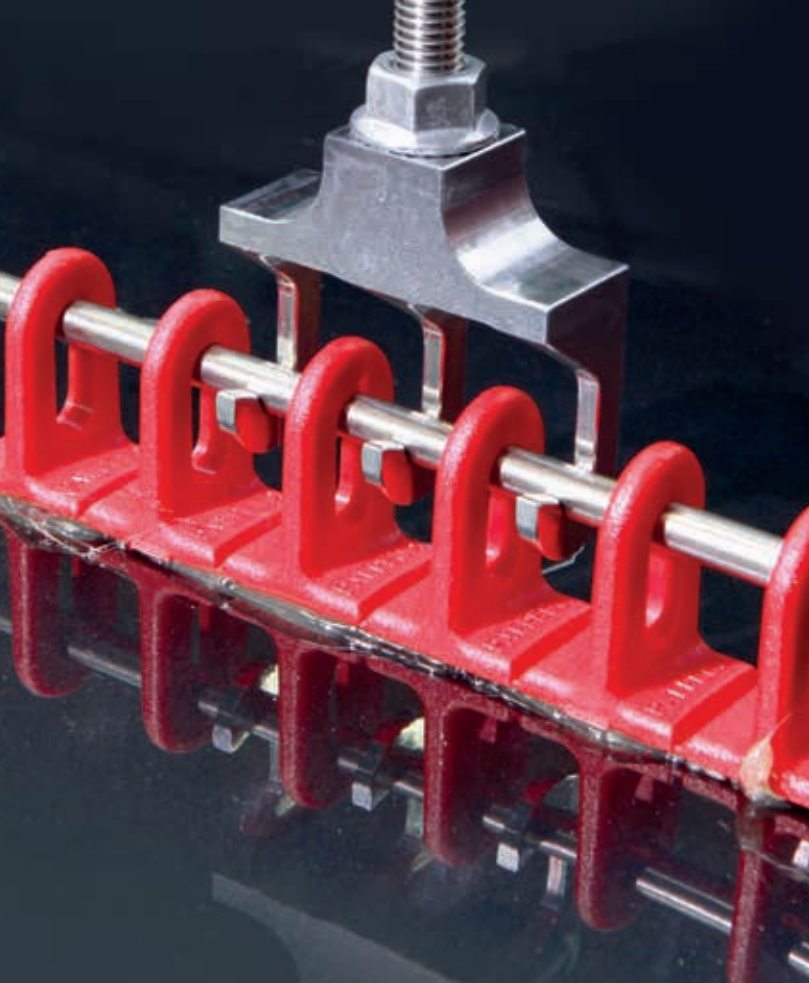

PAINTLESS DENT REPAIR + GLUE PULLING REPAIR

DENT PULLING INDUCTOR

- Inducteur débosselage - Dellenmatrix

GYS
DUCTION
AUTO + Dent pulling
inductor
054776

= GYS
DUCTION AUTO
DENT REPAIR
054981



Youtube



Licensed by
BETAG.Innovation

🔌	🔌	⚡	Freq.	INTEGRATED TECHNOLOGY	❄️	Cable (m)	📦	⬆️
50 Hz	A	W	kHz	PFC	FV	Liquid Cooling	Inductor	LxWxH cm / kg
230V, 1~	16	2 400	35+120	▪	▪	—	2 2.5	52 x 30 x 37 / 9.4
								37 x 21 x 37 / 7.5

DENT PULLING INDUCTOR

- Inspection carrosserie - Ausbeul Induktor

Planche flexible pour inspection de la carrosserie - Ausbeul-Matrix
Ø 800 mm
059122

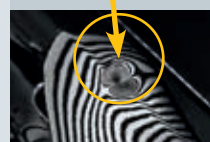

OPTION
Freezer spray
- Spray refroidisseur
-50 °C
400 ml
(x 12)
048898

PAINTLESS DENT REPAIR MAGNETIC KIT

- Kit magnétique de débosselage sans peinture
- Magnetisches Ausbeul-Kit

053168

EXELTOOLS



1010 mm - 40"

705 mm - 28"

610 mm - 24"

510 mm - 20"

DENT PULLING KIT (PAINTLESS)

- Kit débosselage sans peinture - Dellenausbeulhebel-Set

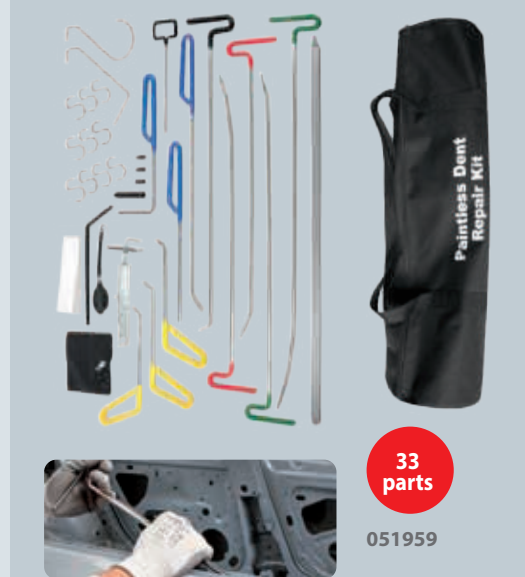

33
parts

051959

AIR CUSHION KIT

- Kit coussins gonflables - Luftpolster-Spreizkissen-Satz



051942

PAINTLESS DENT REPAIR LAMPS

- Lampes de débosselage
- Ausbeullampe

ULTRA LIGHT
CARBON X40 PW
053175

EXELTOOLS

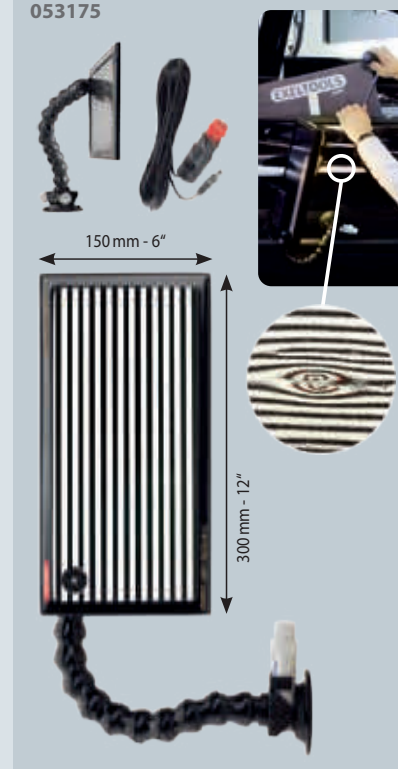

150 mm - 6"

300 mm - 12"

PAINTLESS DENT REPAIR LAMPS

- Lampes de débosselage
- Ausbeullampe

083936

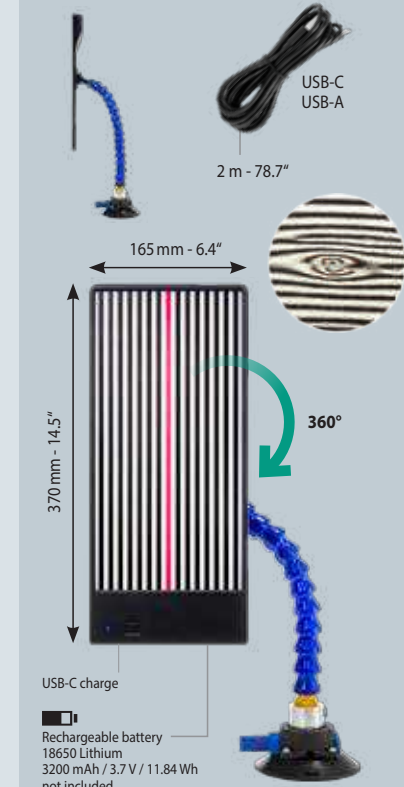

USB-C
USB-A

2 m - 78.7"

165 mm - 6.4"

370 mm - 14.5"

360°

USB-C charge

Rechargeable battery

18650 Lithium

3200 mAh / 3.7 V / 11.84 Wh

not included

SET OF 6 PENCIL PUNCHES

- Kit de 6 coins de frappe - Beulenstemmer-Satz mit 6 Tefloneinsätzen

052888

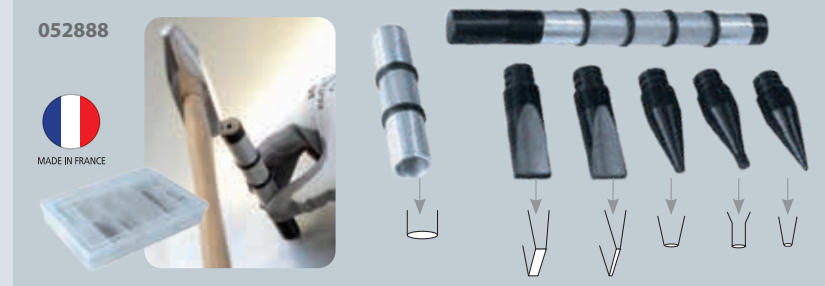

PNEUMATIC INERTIA HAMMER

- Marteau inertie pneumatique - Unterdruck-Schlaghammer

051904

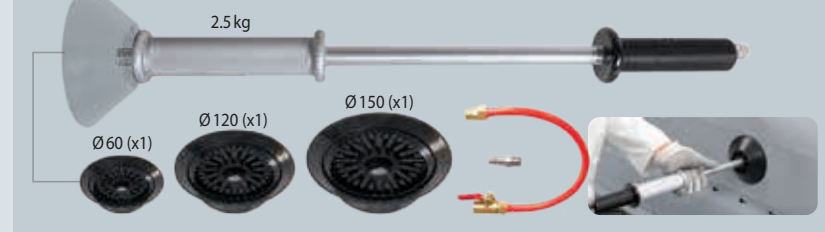

2.5 kg

Ø 60 (x1)

Ø 120 (x1)

Ø 150 (x1)

PUMP AIR SUCTION SLIDE HAMMER

- Marteau à inertie à ventouses (pompage manuel) - Man. Unterdruck-Schlaghammer

1,1 kg

048683

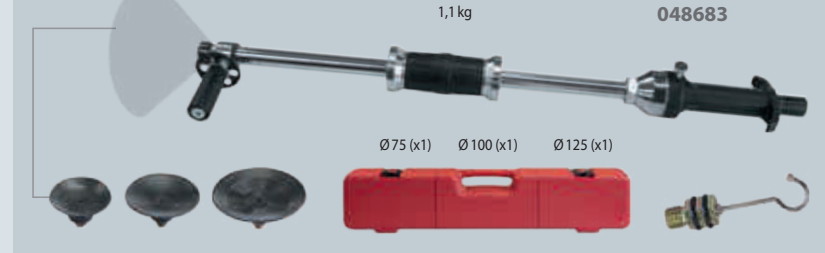

Ø 75 (x1)

Ø 100 (x1)

Ø 125 (x1)



PDR: Paintless Dent Repair
- Débosselage rapide et sans peinture
- Lackschadenfreies Ausbeulen

PAINTLESS DENT REPAIR

GLUE PULLER PRO (Acier/Alu • Steel/Alu)



Glue Puller PRO
058699

Glue Puller PRO EXPORT
230 V 059160

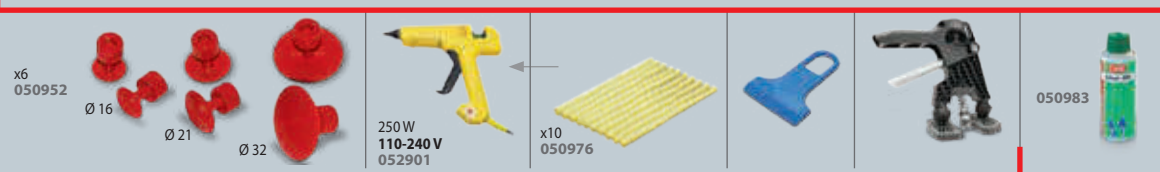

BARRETTES ANNEAUX PLASTIQUE - Plastic Multipads Ösen-Klebepads

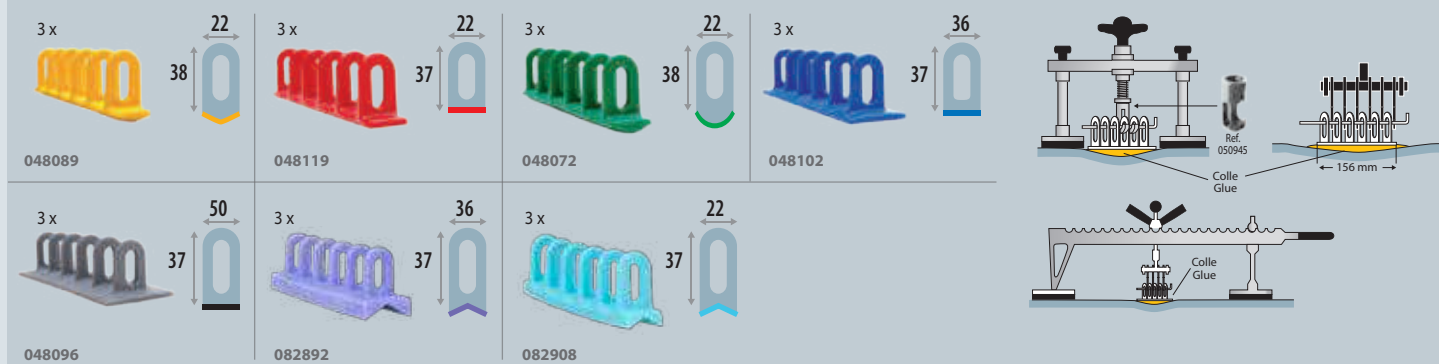

OPTIONS

Pulling handle 3 claws - Poignée de tirage 3 dents - Handzugkralle 3-fach
057326



Slide hammer 380 g
- Marteau à inertie 380 g
- Gleithammer 380 g

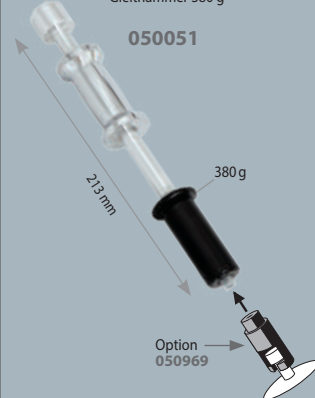

Slide hammer 500 g
- Marteau à inertie 500 g
- Gleithammer 500 g

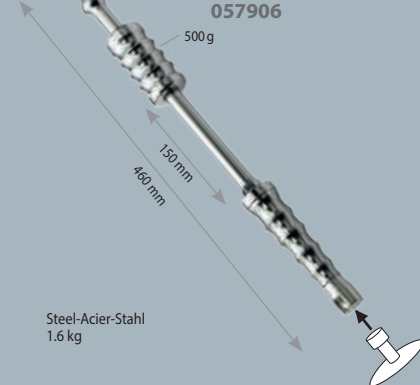

Set of 2 knives to cut glued reinforcements
- Jeu de 2 couteaux pour découpe de renforts colles
- 2-er Set Messer zur Klebepadentfernung



Workstation 054233	Set of pencil punches with 6 teflon tips 052888	Infrared thermometer 079922 Heat Gun 066311	Levelling bar 050693 6 Gripping multihook head 049734	3 Lifting rods 150/300/500 mm 050792	Set of 3 conical plastic multipads 048096 048072 048089 048119 048102	Slide hammer 057906	Set of 6 glue tips 050952	Glue Puller PRO 058699	Glue Puller PRO Export 059160	33PC Paintless dent repair kit 051959 PDR Light ultra light carbon X40PW 053175	Mini puller 050921 Aluminium clamp 2 050945
--------------------	---	--	--	--------------------------------------	---	---------------------	---------------------------	------------------------	-------------------------------	--	--

GYSMART GLUE PULLING KIT 076051					✓						
GYSMART GLUE PULLING KIT EXPORT 076105				✓					✓		
GYSMART GLUE PULLING KIT PLUS 076082					✓						✓
GYSMART GLUE PULLING KIT PLUS EXPORT 076129				✓						✓	



GPR: Glue Pulling Repair
- Débosselage par colle
- Lackschadenfreies Ausbeulen

GLUE PULLING REPAIR



GPR I-BAR MINI



080324



GPR FLEXIBLE TABS

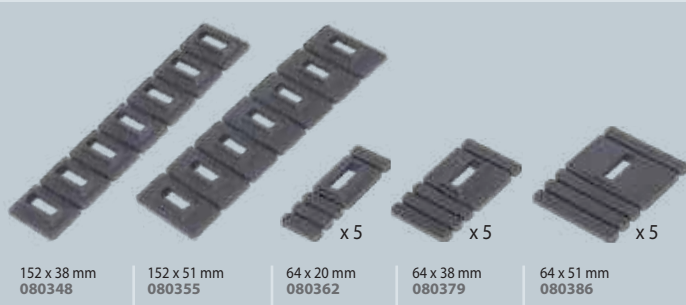

GPR FLAT TABS

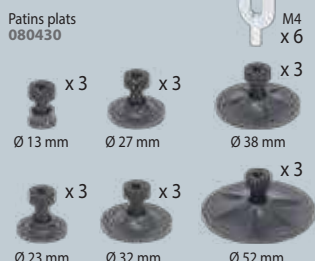

GPR 3D TABS



GPR 3D CURVE TABS

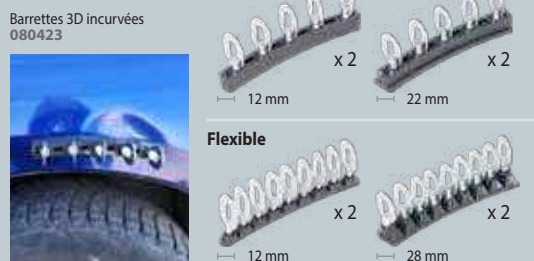

GPR UNIVERSAL TABS

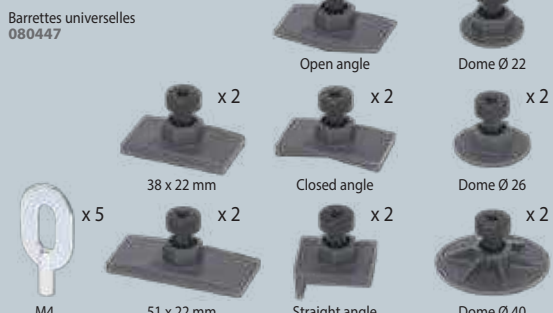

GPR FOLD TABS

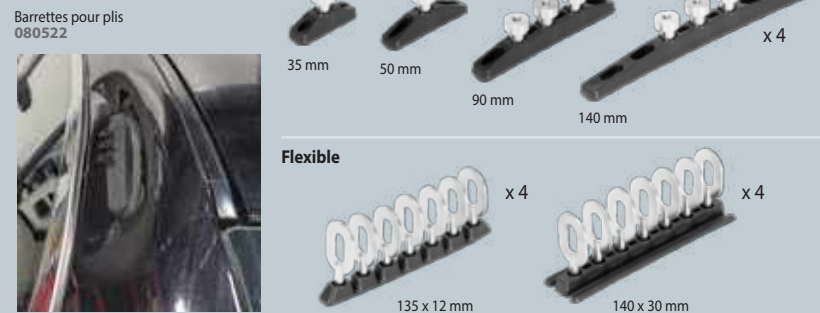

GPR HAIL IMPACT TABS



GPR BAR TABS

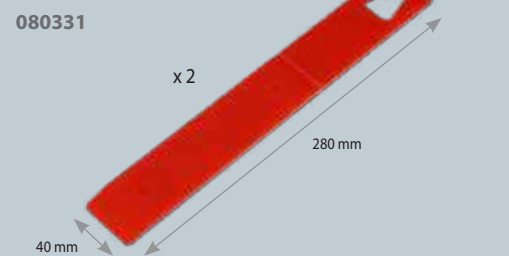

GLUE GUN 400W - Pistolet à colle chaude 400W



GPR PRO KIT

080317



1	GPR I-bar mini	51 mm	x 1
GPR Flexible tabs			
2	64 x 20 mm		x 1
	64 x 38 mm		x 1
	64 x 51 mm		x 1
GPR Long tabs			
3	152 x 38 mm		x 1
	152 x 51 mm		x 1
4	GPR Plastic hooks		x 10
5	GPR Bar tab		x 1
GPR 3D tabs			
6	12 mm		x 1
	22 mm		x 1
GPR 3D curved tabs			
7	51 x 38 mm		x 1
	101 x 38 mm		x 1
8	GPR M4 steel hooks		x 5
GPR Universal tabs			
	Flat 38 x 22 mm		x 1
	Flat 51 x 22 mm		x 1
9	Open angle 38 x 22 mm		x 1
	Closed angle 38 x 22 mm		x 1
	Straight angle 27 x 22 mm		x 1
	Dome Ø 22 mm		x 1
	Dome Ø 26 mm		x 1
	Dome Ø 40 mm		x 1
GPR Flat tabs			
	Ø 13 mm		x 1
	Ø 23 mm		x 1
10	Ø 27 mm		x 1
	Ø 32 mm		x 1
	Ø 38 mm		x 1
	Ø 52 mm		x 1
GPR Bars for folds			
	35 mm		x 1
	50 mm		x 1
	90 mm		x 1
	140 mm		x 1
	Flexible 135 mm		x 1
	140 x 30 mm		x 1
12	GPR Glue sticks		x 10



Isopropyl alcohol 99.9% + spray - Alcool isopropyloque 99,9% + vaporisateur 082236

Heat gun - Décapeur thermique 066311

230 V only

Digital display - Affichage numérique

I: 100/300°C (450 W)
II: 300/650°C (1500 W)
Air flow: 450 l/min

1 L 600 ml

Gas hot air gun - Pistolet à air chaud autonome à gaz 060777

Gas included - Bouteille incluse

Blow torch - Lampe à souder 052741

Gas not included - Bouteille non incluse

Novacet + Butane/Propane/Propylène 040441

HIGH QUALITY

380 ml (220 g)

Infrared thermometer - Thermomètre infrarouge 079922

Adjustable emissivity: 0.10-1.00

-50--+600°C
-58--+1112°F

Set of 6 pencil punches - Kit de 6 coins de frappe 052888

(p. 47)

3 plastic wedges - 3 cales plastiques 051294

Lifting rod 180 mm - Tige de tirage 180 mm 082915

Pulling hand 3 claws - Poignée de tirage 3 dents 057326

(p. 48)

4 tooth claw - Ø M10 / M14 049758

Slide hammer 500g - Marteau à inertie 500g 057906

(p. 48)

Slide hammer 1.7kg - Marteau à inertie 1,7kg 051201

(p. 10)

Glue Lifter 057364

included 061392

(p. 48)

Arc Puller Premium 065161

included Alu 3 065161

(p. 19)

Arc Puller Premium Pro 072572

included Alu 4 065185

option Steel M14 079830

(p. 19)

Premium Pro Levelling bar 900 mm 071643

(p. 22)

Airfix Draw Aligner 077379

(p. 39)



RESISTANCE SPOT WELDING

RANGES	54
--------	----

PRESENT MACHINES

PORTASPOT / 100 R.CX / B.P.LX	56
BP GENIUS	58
PTI-S7 / PTI PREMIUM PRO	60
PTI GENIUS	62

NEW MACHINES WITH COLOUR SCREEN

PTI NEO	64
PTI MASTER / PTI EXPERT	66

ARMS & CONSUMABLES

G ARMS	68
ACCESSORIES & CONSUMABLES	69
X ARMS / C ARMS	70



PORTASPOT / GYSPOT

RESISTANCE SPOT WELDING

PORTASPOT 230

6 300 A 120daN

Air cooled

230V
022256

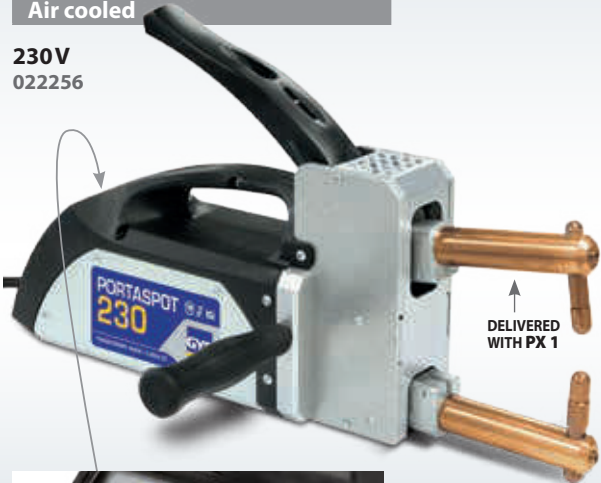

DELIVERED WITH PX 1



ARMS Ø 23 mm

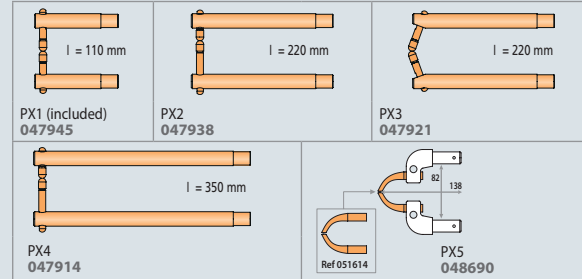

ELECTRODES

EX40 Short electrode 40 mm 047884	EX60 Medium electrode 60 mm 047891	EX80 Long electrode 80 mm 047907
---	--	--

CAPS & ACCESSORIES

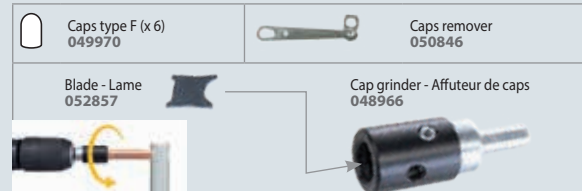

50/60 Hz	A	A	A	mm	V	m	mm ²	LxWxH cm / kg
1 x 230V	16(D)	6 300	8 900	2+2	2.45	2.5	3x2.5 H05VVf	OK 41 x 18 x 22 / 11.3

GYSPOT 100R-CX

10 000 A 550 daN (X) 350 daN (C)

For mild steel, HSS, UHSS

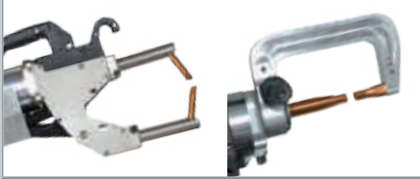

Air cooled

Traceability software
Save spot welding configuration and export data



3 x 400V
022317



OPTIONS 100R-CX

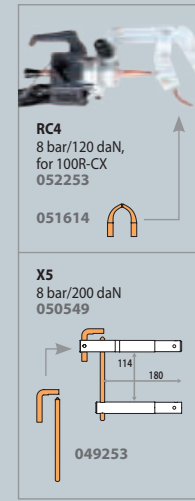

included	019652	058804
Monopoint/Spot 049291	▪	▪
Inertia hammer 049482 + 049802	▪	▪
Spotter box pro 050075	▪	▪
Top support box	▪	▪
Contact grease 050440	▪	▪
Caps remover 050846	▪	▪
Cable support	▪	▪
RX1 051034	▪	▪
RX3 051058	▪	▪
RC1 051065	▪	▪
RC2 051072	▪	▪
RC3 051089	▪	▪

OPTIONS

<p>050068</p> <p>x10 (x20: 052239)</p> <p>x6 (x6: 049994)</p> <p>Caps type A box 048935</p> <p>Caps type F box 077119</p>	<p>x18 (x6: 049987)</p> <p>x18 (x6: 049970)</p> <p>x40 (x6: 049987)</p> <p>x40 (x6: 049970)</p>	<p>Cooling liquid - Liquide de refroidissement - Kühlmittel - Enfriamiento líquido - Refrigeração líquida</p> <p>2L 082212</p> <p>5L 062511</p> <p>10L 052246</p>	<p>Protection cover for BP 050853</p> <p>S1 < nov 2010 048171</p> <p>S2 > nov 2010 048188</p>
---	---	---	---

GYSPOT BP-LX

13 000 A 550 daN

For mild steel, HSS, UHSS

Boron steel



Liquid cooled

BP BODYPROTECT
Unique electro-magnetic field protection

Traceability software
Save spot welding configuration and export data



019652

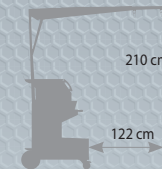

included	019652	058804
Gyspot BP-LX	▪	▪
Monopoint/Spot 049291	▪	▪
Spotter box pro (p.10) 050075	▪	▪
Inertia hammer 049482 + 049802	▪	▪
X1 050501	▪	▪
X4A (x2) + X4B + X4C + X2 020733	▪	▪
Liquid cooling (10l) 052246	▪	▪ (x3)



MADE IN FRANCE 62135	50/60 Hz	A D curve	Spots/min (max) ± 2.5+2.5	RMS A	mm		Uo V	Cables				100% CU	LxWxH cm / kg
					↕	↔		↔	↔	↔	↔		
GYSPOT 100R.CX	3 x 400V	32 (22 kVA) 40 (28 kVA) 50 (35 kVA)	2 6 10	10 000	2.5+2.5+2.5	1.5+3	16	2.5 m, air Ø 200 mm ²	2.5 m, air Ø 200 mm ²	2.5 m, air Ø 150 mm ²	8 m, 4 x 6 H07RNF	OK	61 x 79 x 71 / 137
GYSPOT BPLX	3 x 400V	32 (22 kVA) 40 (28 kVA) 50 (35 kVA)	2 6 10	13 000	2.5+2.5+2.5	1.5+3	16	2.5 m, liquid	—	2.5 m, air	8 m, 4 x 6 H07RNF	OK	65 x 80 x 205 / 164.5



GYSPOT

RESITANCE SPOT WELDING BP GENIUS

G
ARMS



MADE IN FRANCE

G-clamp front
body + protection
078765

**ULTRA LIGHT
& COMPACT**
6.5 kg
(Gyro & G1 included)

550 daN

LIQUID COOLED
REFROIDISSEMENT
LIQUIDE
Ø 10 mm

6.5 kg
(Gyro & G1 included)



Youtube

OPTIONS

Caps type A box
048935
x40 (x6: 049987)
Caps type F box
077119
x40 (x6: 049970)

x20 (x6: 049987)
x6 (x6: 049970)
x2 (x1: 050617)
073449

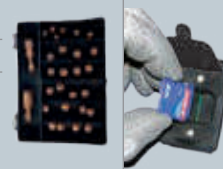

SD CARD
050914

Cooling liquid - Liquide
de refroidissement
- Kühlmittel
- Enfriamento líquido
- Refrigeração líquida

2L 082212
5L 062511
10L 052246



Protection
cover
- Housse de
protection
- Schutzhaube
for BP & PTI
050853



10-14 kg
059696

FAST OPEN XL

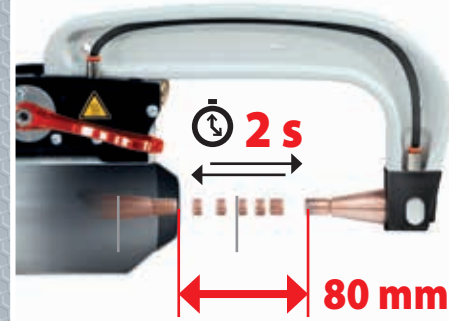

EASY



GYRO INTEGRATED



PERFECT ELECTRICAL CONNECTION



AUTO

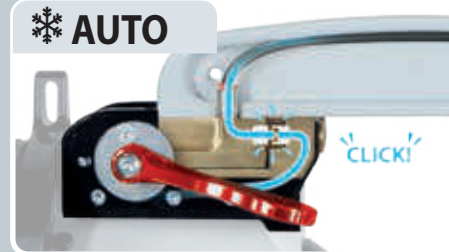

GYSPOT BP GENIUS

13 000 A
550 daN

For mild steel, HSS, UHSS **Boron steel**

BP BODYPROTECT
Unique electro-magnetic field protection
by GYS

Traceability software
Save spot welding configuration
and export data



	023550	023451	082250
Gyspot BP GENIUS	220V		400V
Monopoint/Spot 049291	▪	▪	▪
Spotter box pro (p.10) 050075	▪	▪	▪
Inertia hammer 049482 + 049802	▪	▪	▪
Caps remover 050846	▪	▪	▪
Arm support	▪	▪	▪
G1 022768	▪	▪	▪
G2 + G3 + G4 022898	▪	▪	▪
Liquid cooling (10L) 052246	▪	▪	(x3)
Caps type A box 048935	▪	▪	▪
Protection cover 050853	▪	▪	▪



59

GYSPOT BP GENIUS

LIQUID COOLED

MADE IN FRANCE 62135	50/60 Hz	RMS A	-AM- A D curve	Spots max 2.5+2.5 mm	Uo V	mm			Cables			100 % CU	cm	kg													
						mm	mm	mm	mm	mm	mm																
GYSPOT BP GENIUS 400V	3 x 400V	13 000	32 (22 kVA) 40 (28 kVA) 50 (35 kVA)	2 6 10	16	2.5+2.5+2.5	1.5 + 3	2.5 m, Ø 200 mm ² , Liquid	2.5 m, Ø 150 mm ² air	8 m 4x6 mm ² H07RN-F	OK	65 x 80 x 205	171														
														GYSPOT BP GENIUS 220V	3 x	200V 10 500 208V 11 000 230V 12 000 240V 12 500	60 (21-25 kVA) 80 (28-33 kVA) 100 (35-41 kVA)	2 6 10	15 15.5 17 18	2.5+2.5+2.5	1.5 + 3	2.5 m, Ø 200 mm ² , Liquid	2.5 m, Ø 150 mm ² air	8 m 4x6AWG (500V)	OK	65 x 80 x 205	178



GYSPOT

RESISTANCE SPOT WELDING

GYSPOT PTI-s7

14 500 A
550 daN

For mild steel, HSS, UHSS Boron steel

- FUSE 20 A
- Double pressure
- Ø 10 mm
- 9.9 kg (included C1)

TRANSFORMER INSIDE

Liquid cooled

Traceability software
Save spot welding configuration and export data

Convert PTI S-7 to Premium Pro
C ARMS G ARMS

Kit Renov PTI Premium Pro

220V
072367

400V
072541

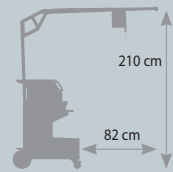

C ARMS



9.9 kg

	220V	400V	
Gyspot PTI-s7	6M 022195	4M 020894	4M 067998
Contact grease 050440	▪	▪	▪
Caps remover 050846	▪	▪	▪
Arm panel	▪	▪	▪
C1 021402	▪	▪	▪
C2 + C3 + C4 060821	▪	▪	▪
C6 022409	▪	▪	▪
Gyro 360° 051720	▪	▪	▪
Complete gun kit 067318	▪	▪	▪
Liquid cooling (10L) 052246	▪	(x3)	

OPTIONS

GYRO 360° for PTI S-7 051720	Kit gun for PTI S-7 067318	Cooling liquid - Liquide de refroidissement - Kühlmittel - Enfriamiento líquido - Refrigeração líquida	Protection cover - Housses de protection - Schutzhaube
	200 mm ² 1.6 m	2L 082212 5L 062511 10L 052246	for BP & PTI 050853
	300 mm ² 1m		10-14 kg 059696

MADE IN FRANCE 62135	50/60 Hz	RMS A	-AM- A D curve	Spots/min (max)	U _o		mm			Cables			cm	kg
					V	mm	mm	mm	mm	mm	mm			
GYSPOT PTI-s7	3 x 400 V	14 500	20 (14 kVA)	10	7.3	2.5+2.5+2.5	1.5 + 3	4 m, liquid or 6 m, liquid	OPTION 067318 : 1.6 m, Ø 200 mm ²	8 m, 4x4 mm ² H07RNF	65 x 80 x 230	105.3		
GYSPOT PTI-s7 220 V	3 x	200 V 12 500	40 (14-16 kVA)	10	6.5	2.5+2.5+2.5	1.5 + 3	4 m, liquid or 6 m, liquid	OPTION 067318 : 1.6 m, Ø 200 mm ²	8 m, 4xAWG8 (500W)	65 x 80 x 230	115.7		
208 V 13 000		6.7												
230 V 14 500		7.4												
240 V 14 500		7.7												

GYSPOT PTI PREMIUM PRO

14 500 A
550 daN

For mild steel, HSS, UHSS Boron steel

- FUSE 25 A
- Double pressure
- Ø 10 mm
- 10.3 kg (included G1)

TRANSFORMER INSIDE

Liquid cooled

Traceability software
Save spot welding configuration and export data

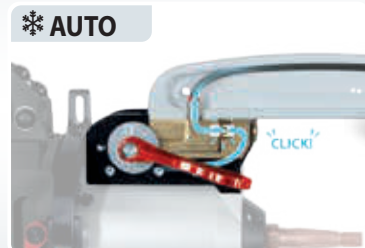

OPTIONS

Kit gun for PTI Premium Pro 067226	G11 for PTI Premium Pro 071766
300 mm ² 1.8m	25 mm max 120 mm
300 mm ² 1m	

MADE IN FRANCE 62135	50/60 Hz	RMS A	-AM- A D curve	Spots/min (max)	U _o		mm			Cables			cm	kg
					V	mm	mm	mm	mm	mm	mm			
GYSPOT PTI PREMIUM PRO 400V	3 x 400 V	14 500	25 (14 kVA)	10	7.4	2.5+2.0+2.0	1.5 + 3.0	6 m, liquid	OPTION 067226 : 1.8 m, Ø 300 mm ²	8 m, 4x4 mm ² H07RNF	65 x 100 x 230	109		
GYSPOT PTI PREMIUM PRO 220V	3 x	200 V 12 500	50 (17-21 kVA)	10	6.5	2.5+2.0+2.0	1.5 + 3.0	6 m, liquid	OPTION 067226 : 1.8 m, Ø 300 mm ²	8 m, 4xAWG8 (500W)	65 x 100 x 230	119		
208 V 13 000		6.7												
230 V 14 500		7.4												
240 V 14 500		7.7												

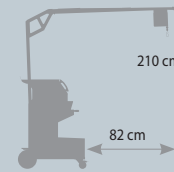

G ARMS



10.3 kg

	220V	400V	
Gyspot PTI Premium Pro	6M 072206	072183	082243
Caps remover 050846	▪	▪	▪
Arm panel	▪	▪	▪
G1 022768	▪	▪	▪
G2 + G3 + G4 022898	▪	▪	▪
Liquid cooling (10L) 052246	▪	(x3)	
Caps type A box 048935	▪	▪	▪
Protection cover 050853	▪	▪	▪

GYSPOT PTI

INVERTER





GYSPOT

RESISTANCE SPOT WELDING PTI GENIUS



MADE IN FRANCE

550 daN

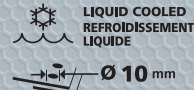

11.3 kg
(Gyro & G1 included)

FAST OPEN XL

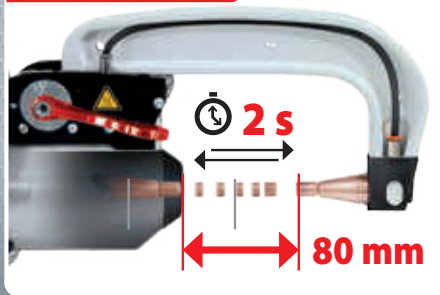

GYRO INTEGRATED

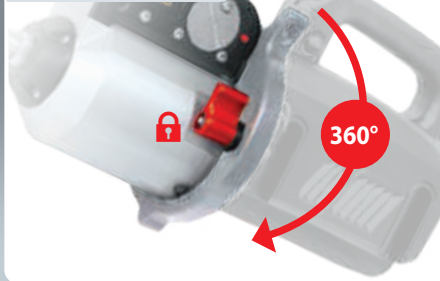

PERFECT ELECTRICAL CONNECTION

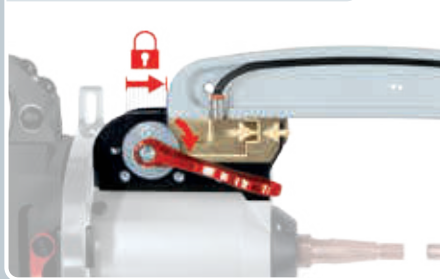

AUTO

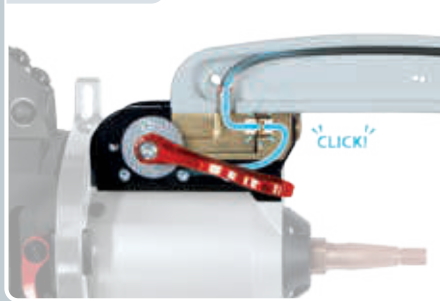

OPTIONS



G ARMS

G-clamp front body + protection 078765

TRANSFORMER INSIDE

Control command
- Contrôle de commande

Motorised cable support
- Potence électrique
- Elektrisch verstellbarer Kabelsupport



UPSIDE DOWN POSITION

GYSPOT PTI GENIUS

14 500 A

550 daN

For mild steel, HSS, UHSS **Boron steel**

TRANSFORMER INSIDE

Liquid cooled

Traceability software
Save spot welding configuration and export data



	024878	082267	024854	024892
	400V		220V	480V
Gyspot PTI-GENIUS				
Caps remover 050846	▪	▪	▪	▪
Arm support				
G1 022768				
G2 + G3 + G4 022898				
Liquid cooling (10L) 052246		(x3)		
Caps type A box 048935				
Protection cover 077126				

Ergonomic

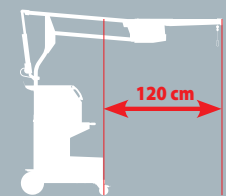

Included Cable support
ULTRA RESISTANT



ELECTRIC MOTOR

Control Command

Electrode storage
- Rangement pour électrodes

6 m

High stability - Grande stabilité

OPTIONS

Kit gun 067226



MADE IN FRANCE 62135	50/60 Hz	RMS A	-I-AM- A D curve	Spots/min (max)	U _o V	mm		Cables		cm	kg		
						↕	↔	↕	↔				
GYSPOT PTI GENIUS 400V	3 x 400 V	14 500	25 (17 kVA)	20	7	2.5+2.5+2.5	1,5 + 3	6 m, Liquid	8 m 4x4 mm ² H07RN-F	71 x 90 x 200	127.7		
												200	12 500
												208	13 000
												230	14 500
GYSPOT PTI GENIUS 220 V	3 x 230 V	14 500	50 (17-21 kVA)	20	7	2.5+2.5+2.5	1,5 + 3	6 m, Liquid	8 m 4xAWG8 (500W)	71 x 90 x 200	136.2		
												240	14 500
												240	14 500
GYSPOT PTI GENIUS 480V	3 x 480 V	14 500	20 (17 kVA)	20	7	2.5+2.5+2.5	1,5 + 3	6 m, Liquid	8 m 4xAWG12 (500W)	71 x 90 x 200	128.7		

GYSPOT PTI GENIUS

LIQUID COOLED



RESISTANCE SPOT WELDING PTI NEO

NEW



MADE IN FRANCE

Manual Mode

Direct entry of welding current, time and pressure -
Entrée directe du courant et temps de soudage et de la pression

3.5" colour screen
Easy navigation interface



Traceability software
Save spot welding configuration and export data



Automatic Mode

Automatic detection of the welding parameters
- Détection automatique des paramètres de soudage



Synergic Mode

User defined welding parameters
- Programmation par l'utilisateur



Car Manufacturer Mode

Specific Car Manufacturer pre-programmed welding parameters
- Points de soudure constructeur préprogrammés



G ARMS

EASY OPENING

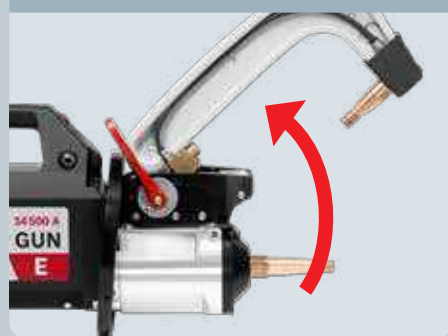

PERFECT ELECTRICAL CONNECTION



AUTOMATIC HYDRAULIC CONNECTION



OPTIONS

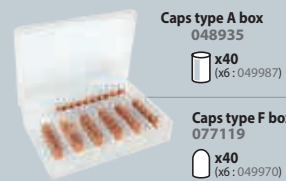

Caps type A box
048935
x40 (x6: 049987)
x6 (x6: 049970)
x2 (x1: 050617)
073449

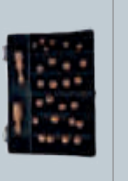

EASY USB UPDATE
USB key 16 Gb
062344

Cooling liquid - Liquide de refroidissement
- Kühlmittel
- Enfriamiento líquido
- Refrigeração líquida
2L 082212
5L 062511
10L 052246



Protection cover
- Housse de protection
- Schutzhaube
062733



GYSPOT PTI NEO

13000 A
550 daN

For mild steel, HSS, UHSS Boron steel

TRANSFORMER INSIDE

Liquid cooled : 5 litres

Automatic Mode

Automatic detection of the welding parameters



3.5" colour screen

Easy navigation interface



Traceability software

Save spot welding configuration and export data



	024779	084834	077362	084841
Gyspot PTI-NEO	400V		208-240V	
Caps remover 050846	■	■	■	■
G1 022768	■	■	■	■
G2 + G4	■	■	■	■
	ALL IN 1 BOX	ALL IN 1 BOX	ALL IN 1 BOX	ALL IN 1 BOX

78.5 x 58.5 x 64 cm
6 units/palette

G arms storage



G1, G2, G3 storage

OPTION

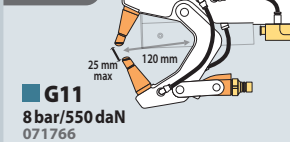

G11
8 bar/550 daN
071766

G ARMS



9.7 kg
VERY LIGHT

OPTION

NEW

QUICK FIX Single sided gun
- Kit Pistolet monopoint
082823



EASY CONNECTION



HSS
UHSS
Boron

NEW
05/2024

LIGHT TROLLEY

4 m

LIQUID COOLING
5 Litres

MADE IN FRANCE CE NORX 62135	50/60 Hz	RMS A	TAM A D curve	Spots/min (max)	Uo V	mm		Cables				cm	kg	
						mm	mm	(option)	(option)	(option)	(option)			
GYSPOT PTI NEO 400V	3 x 400V	13 000	20	10	7.7	2.5+2.0+2.0	1.5+3.0	4 m, Liquid	1.8 m, Ø 300 mm ²	1 m, Ø 300 mm ²	8 m 4x4 mm ² HOT8NF	63 x 76 x 127	57	
														6.7
														6.9
														7.7
GYSPOT PTI NEO 208-240V	3 x	200V	10 900	10	6.9	2.5+2.0+2.0	1.5+3.0	4 m, Liquid	1.8 m, Ø 300 mm ²	1 m, Ø 300 mm ²	8 m 4xAWG8 (SOOW)	63 x 76 x 127	62	
		208V	11 300											
		230V	12 500											
		240V	13 000											



GYSPOT

RESISTANCE SPOT WELDING

PTI MASTER PTI EXPERT



MADE IN FRANCE

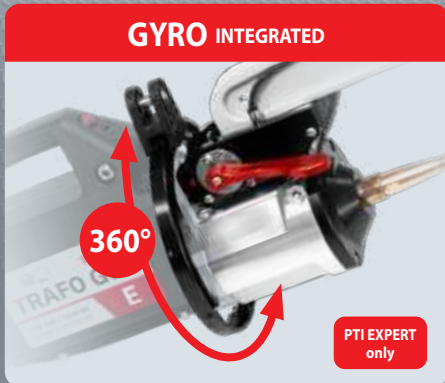
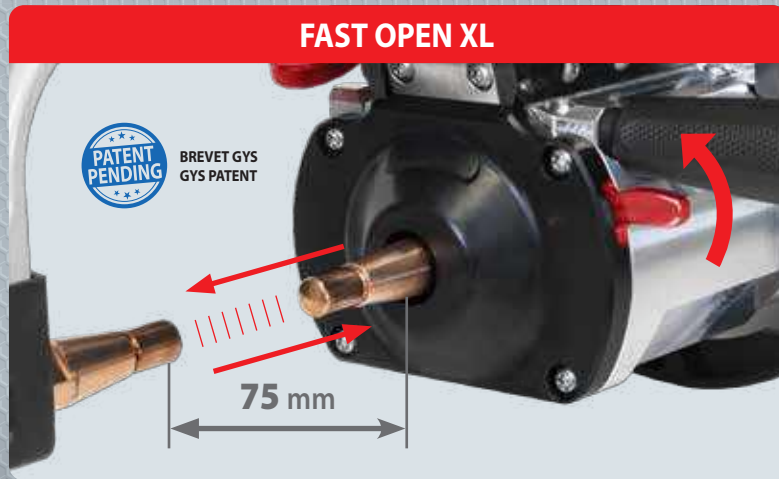

TRANSFORMER INSIDE

MASTER 10.3 kg
(G1 included)

EXPERT 11.8 kg
(Gyro + G1 included)

LIQUID COOLED
Refróidissement liquide

OPTIONS

<p>G-clamp front body + protection 078765</p>	<p>NEW QUICK FIX Single sided gun - Kit Pistolet monopoint 082823</p>	<p>Cooling liquid - Liquide de refroidissement - Kühlmittel - Enfriamento líquido - Refrigeração líquida</p> <p>2L 082212 5L 062511 10L 052246</p>	<p>Protection cover for PTI MASTER 062733</p>	<p>Protection cover for PTI EXPERT 050853</p>	<p>10-14 kg 059696</p>
---	--	--	---	---	----------------------------

TRANSFORMER INSIDE	For mild steel, HSS, UHSS Boron steel	Automatic Mode	3.5" colour screen	Traceability software
---------------------------	--	-----------------------	---------------------------	------------------------------

GYSPOT PTI MASTER

13000 A
550 daN

Liquid cooled : 5 litres

GYSPOT PTI EXPERT

14500 A
550 daN

Liquid cooled : 30 litres

GYSPOT PTI MASTER 400V

13 000 A 400 V • 3 phase

083264

GYSPOT PTI EXPERT 400V

14 500 A 400 V • 3 phase

083943

GYSPOT PTI MASTER 208-240V

13 000 A 208-240 V • 3 phase

083257

GYSPOT PTI EXPERT 208-240V

14 500 A 208-240 V • 3 phase

083950



Country	Voltage	RMS A	A D curve	Spots/min (max)	Uo V	mm		Cables				cm	kg				
						Gun	Gun (option)	Gun (option)	Gun (option)	Gun (option)							
MADE IN FRANCE	3 x 400 V	13 000	20	10	7.7	2.5+2.0+2.0	1.5 + 3.0	4 m, Liquid	1.8 m, Ø 300 mm ²	1 m, Ø 300 mm ²	8 m, 4x4 mm ² H07RNF	63 x 76 x 127	58				
														200 V	10 900	6.7	
														208 V	11 300		6.9
														230 V	12 500		
240 V	13 000	8															
Japan, USA, Brazil, Italy	3 x 208-240 V		13 000	30	10	6.7	2.5+2.0+2.0	1.5 + 3.0	4 m, Liquid	1.8 m, Ø 300 mm ²	1 m, Ø 300 mm ²	8 m, 4xAWG8 (500V)	63 x 76 x 127	63			
															200 V	12 500	
															208 V	13 000	
		230 V													14 500		
Japan, USA, Brazil, Italy	3 x 400 V	14 500	25	10	7.4	2.5+2.0+2.0	1.5 + 3.0	5 m, Liquid	1.8 m, Ø 300 mm ²	1 m, Ø 300 mm ²	8 m, 4x4 mm ² H07RNF	65 x 100 x 230	109				
														200 V	12 500		
														208 V	13 000		
														230 V	14 500		
Japan, USA, Brazil, Italy	3 x 208-240 V	14 500	50	10	6.5	2.5+2.0+2.0	1.5 + 3.0	5 m, Liquid	1.8 m, Ø 300 mm ²	1 m, Ø 300 mm ²	8 m, 4xAWG8 (500V)	65 x 100 x 230	119				
														200 V	12 500		
														208 V	13 000		
														230 V	14 500		

FOR GYSPOT BP GENIUS, PTI PREMIUM PRO & PTI GENIUS

G Arms - Caps Ø13 mm

Bras isolés - Isolated arms - Isolierte Bügel

G2 8 bar/300 daN 022775

G6 8 bar/550 daN 022812

G7 4 bar/150 daN 022829

G11 8 bar/550 daN 022768
for PTI PREMIUM PRO, NEO, MASTER & EXPERT 071766

Kit de maintenance connecteurs pince G - Connectors maintenance kit for G clamp 067295

G arms protections 067288

G4 8 bar/550 daN 022799
Option for G4

G5 8 bar/550 daN 022805
Option for G5

G8 8 bar/550 daN 022836
Option for G8

G1 8 bar/550 daN 022768
Option for G1 & G3

G3 8 bar/550 daN 022782
Option for G1 & G3

G1/G3-SA (Small Access) 067653 (for arms > 02/2021)

G4-SA (Small Access) 064478 (for arms < 01/2021)

G5/G10-SA (Small Access) 067660

G8-SA (Small Access) 067677

G10 8 bar/400 daN 067165
Option for G10 & G12

G12 8 bar/300daN 075238

G5/G10/G12-SA (Small Access) 067660

G14 8 bar/550 daN 080942

G X UNIQUE SYSTEM

AUTOMATIC WELDING FOR X1, X2 & X6

BREVETÉ / PATENTED n° US 11,618,097

G9 | 8 bar/550 daN not for PTI PREMIUM PRO

G9 with X1 Included 022881

X1 050501 550 daN

X2 050518 300 daN

G9 with X6 Included 072275

X6 050587 300 daN

Option SD card 050914

Option PCB 97449C

G ARMS PANELS

G2 + G3 + G4 022898

G2 + G3 + G5 063297

KIT SMALL ACCESS GENIUS for PTI GENIUS 077072

included SA 073579

+ **G1/G3-SA (Small Access)** 134

+ **G4-SA (Small Access)** 156

+ **G5/G10/G12-SA (Small Access)** 220

+ **G8-SA (Small Access)** 368

X/C/G CONSUMABLES - Consommables X/C/G

Type A Cor X clamp Ø 13 mm (x6) 049987

Type B Cor X clamp Ø 13 mm / Ø 5 mm (x6) 055506

Type D Cor X clamp Ø 13 mm (x10) 058507

TYPE F For single sided gun Ø 13 mm (x6) 049970

TYPE G Ø 13 mm (x10) 059672

Caps inclinés - Beveled X2, X4C11 arms Ø 13 mm (x6) 049994

Caps type A box 048935 x40

Caps type F box 077119 x40

Contact grease Graisse contact 050440

Caps remover 050846

Anti-corrosion welding primer - Primaire de soudage anti-corrosion 076822

Spot / Monopoint 049291

073449 x20

050068 x10 x6 x18 x18

CAP GRINDER - Affuteur de caps

Lame - Blade 052857

048966

Optimal speed: 400-800 rpm

Youtube

GYRO 360°

for PTI 051720

STEEL SHEET TRACTION BENCH

- Banc de traction arrache tôle - Blech-Zugbank zur Festigkeitsprüfung

052420

052321 (included)

WELD TEST KIT - Valise test soudure HLE / THLE

- Schweißtestkit im Hartschalenkoffer

050433

Barre d'arrachage / Traction bar + Acier doux / Mild steel 0.65 (x25) + 1.0 (x25) + Acier HSLA 360 - HLE 0.8 (x25) + 1.5 (x25) + Acier DP600 - THLE/UHLE 1.0 (x25) + Acier FB560 - THLE/UHLE 2.5 (x25)

ANTI-ARC PROTECTION 12V

- Protection anti-arc 12 V - Lichtbogenschutz 12V - Protección anti-arco 12V

041318

PROTECTION COVER

- Housses de protection - Schutzhaube

for BP & PTI 050853

for PTI GENIUS 077126

SHEETS SET

- Echantillons de tôles

Acier standard / Standard steel 0.8 (x65) + 1 (x55) + 1.5 (x35) + 2 (x25) + Alu 1 (x45) + 1.5 (x30) + 2 (x20) 055841

ELECTRODE FORCE SENSOR

- Capteur d'effort

052314

TANK DRAINING KIT - Kit de purge réservoir - Kit zur Tankentleerung

058286

for GYSPOT PTI-s7

SD MEMORY CARD

- Carte mémoire SD

SD CARD 050914

KIT WIFI

for Gyspot Inverter PTI GENIUS 070691

COOLING LIQUID

- Liquide de refroidissement - Kühlmittel - Enfrimiento líquido - Refrigeração líquida

2 L 082212

5 L 062511

10 L 052246

RESISTANCE SPOT WELDING

ACCESSORIES

RESISTANCE SPOT WELDING

FOR GYSPOT 32D-X, 100R-CX, BP-LX

550 daN

6,5 kg including X1

- DOUBLE PRESSURE
- LIQUID COOLED / REFRIGÉRISSÉMENT LIQUIDE
- Ø 10 mm

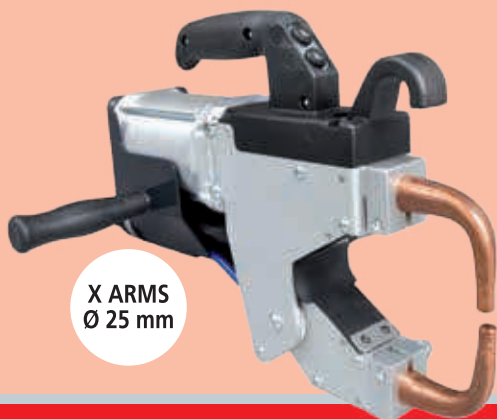

X ARMS Ø 25 mm

X Arms - Caps Ø13 mm

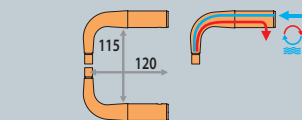

X1 8 bar/550 daN 050501

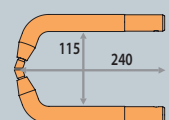

X2 8 bar/400 daN 050518

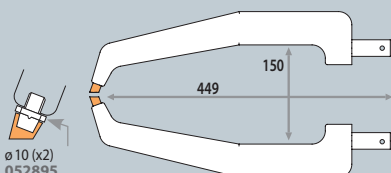

X4 8 bar/120 daN 050532

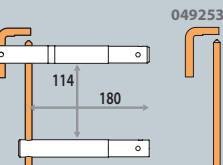

X5 8 bar/200 daN 050549

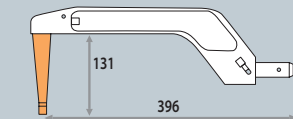

X4A 8 bar/150 daN 020702

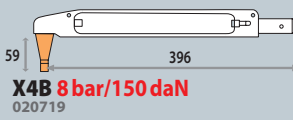

X4B 8 bar/150 daN 020719

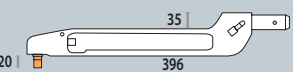

X4C 8 bar/150 daN 020726

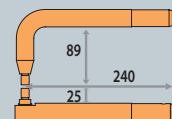

X6 8 bar/400 daN 050587

X4 (A, B & C) combinations

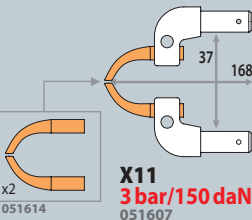
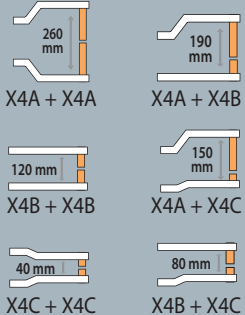

X11 3 bar/150 daN 051607

X ARMS PANELS

X4A (x2) + X5 + X2 022324

X4A (x2) + X4B + X4C + X2 020733

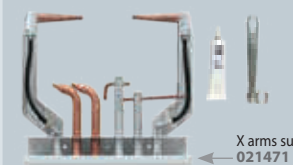

X arms support 021471



X arms support 021471

Remote control (BP)



C ARMS PANELS



C2 + C3 + C4 060821 ALL IN 1 BOX



C10 + C3 + C5 + C6 + C9 076495

FOR GYSPOT PTI

550 daN

Transformer inside

9,9 kg including C1

- DOUBLE PRESSURE
- AIR COOLED + LIQUID COOLED / DOUBLE REFRIGÉRISSÉMENT AIR + LIQUIDE
- Ø 10 mm

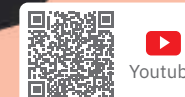

C Arms - Caps Ø13 mm

Bras isolés - Isolated arms - Isolierte Bügel

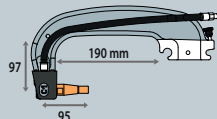

C1 8 bar/550 daN 021402

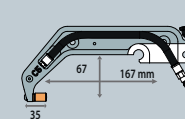

C5 8 bar/550 daN 022393

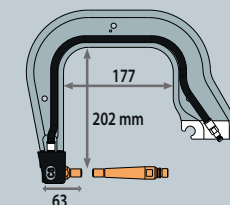

C8 8 bar/550 daN 021440

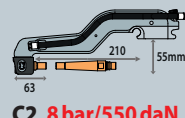

C2 8 bar/550 daN 022386

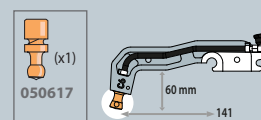

C6 8 bar/300 daN 022409

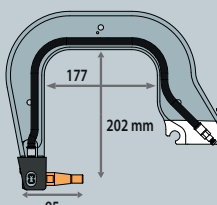

C3 8 bar/550 daN 021419

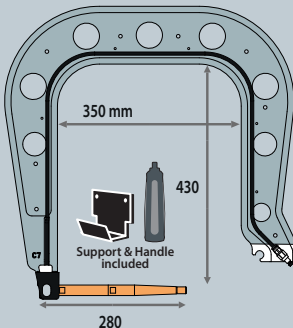

C7 8 bar/550 daN 021433

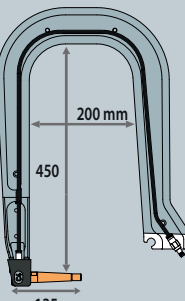

C4 8 bar/550 daN 021426

PTI arm support kit 077577



BP arm support kit 080089

Arm lock pin 062405



X Arms - Caps Ø13 mm

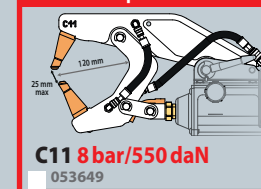

C11 8 bar/550 daN 053649



C12 8 bar/550 daN 022997

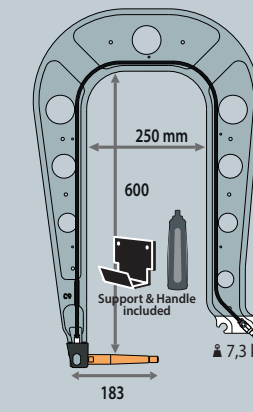

C9 8 bar/550 daN 020078

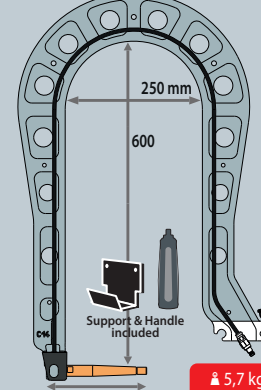

C14 8 bar/400 daN 023543

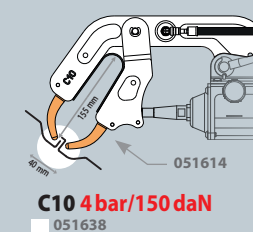

C10 4 bar/150 daN 051638

Option for C7



Option for C9 & C14

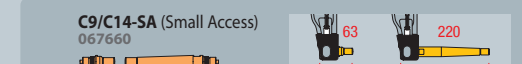



RIVETING



GYSPRESS 10T

6.5 bar 100 kN

10t

063303

070653



Discharge lever
- Levier de décharge - Auslösehebel



Speed control - Contrôle de la vitesse - Regelung
Werkzeuggeschwindigkeit



Pressure control
- Contrôle de la pression - Druckregelung



GYSPRESS 10T COMPLETE PACKS

	HR110 063310	XT11.21 - Extension for HR110 & HR210 058644	Standard 10T tool box 053694	6 x 50 rivets RAP - Nieten SPR 048706	HR210 + HR310 064089	24kN adapter 063822	Trolley+support 055391
GYSPRESS 10T 063303 070653	✓						
GYSPRESS 10T pack 1 066441			✓				
GYSPRESS 10T pack 2 082991				✓			
GYSPRESS 10T pack 3 064744							✓

GYSPRESS 10T	73
GYSPRESS PREMIUM 10T PP	75
WORKSTATION	76
ADAPTERS	78
DIES BOXES & RIVETS	80
ACCESSORIES	83

MADE IN FRANCE	AIR BAR	PRESSURE CONTROL	SPEED CONTROL	↕	⚖	🧳	LxWxH cm / kg
	cm	kg	cm	kg			
GYSPRESS 10T	6.5 bar = 10 t (maxi 10 bar)	0 > 6.5 bar	+ -	39.5 x 180	6.2 (HR110 included)	58 x 50 x 15 / 12.1	



	HR110	HR210	HR310
	063310	063327	063334
GYSPRESS 8T	✓	✓	—
GYSPRESS 10T	✓	✓	✓
GYSPRESS 8T PUSH PULL	✓	✓	✓
GYSPRESS PREMIUM 10T PUSH PULL	✓	✓	✓
GYSPRESS 10T PUSH PULL	✓	✓	✓
GYSPRESS 10T CONNECT	✓	✓	✓



KIT WITH HR210 + HR310 064089

XT31-40 Rallonges bras HR310 pour point milieu - HR310 arm extension for middle point

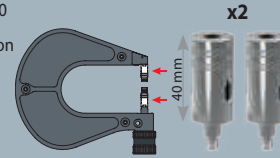

Compatible 8T PP/10T/10T PP x2 066335

OPTIONS



Riveting machine support for changing accessories (arms & dies)
- Support Riveteuse pour changements d'accessoires (bras & matrice)
- Supportständer

↓ 28 x 40 x 21,5 cm
⊗ 45 x 39 x 20 cm / 7,2 kg
054158



Trolley - Chariot

↓ 74 x 51 x 81 cm
⊗ 80 x 123 x 15 cm / 44 kg
054233



Trolley + Support Chariot + Support

↓ 51 x 74 x 122 cm
⊗ 51,2 kg
055391



Pressure sensor - Capteur d'effort 062115



Hydraulic body wrenches (x2) 067325



Temporary - Serre-tôles - fasteners manual mounting

- (x10) Ø 2,4 mm 069664
- (x10) Ø 4,0 mm 069671
- (x10) Ø 4,8 mm 069688
- (x10) Ø 6,4 mm 069695

GYSPRESS 10T PREMIUM PUSH PULL COMPLETE PACKS

	HR110 063310	XT11.21 - Extension for HR110 & HR210 058644	Standard 10T tool box 058631	6 x 50 rivets RAP - Nieten SPR 048706	HR210 + HR310 064089	24kN adapter 063822	Trolley+support 055391
GYSPRESS 10T PREMIUM PUSH PULL 077065	✓						
GYSPRESS 10T PPP pack 1 082519					✓		
GYSPRESS 10T PPP pack 2 082526							✓
GYSPRESS 10T PPP pack 3 082533							✓



GYSPRESS

PREMIUM PUSH PULL

GYSPRESS PREMIUM 10T PUSH PULL

6.5 bar 100 kN

10t

077065

070660



US version 070660



Pressure gauge Psi



UNIQUE 100% No air inclusion maintenance free, no oil refill

UNIQUE PUSH PULL SYSTEM by GYS

AUTO or MANUAL



LARGE OPENING

MORE ACCESS

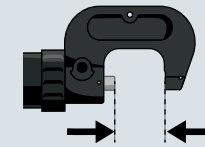

48.5 mm (no dies)
23.5 mm with B1/B2 dies

ERGONOMIC WITH QUICK SELECTION

WORK FASTER



Push/Pull selection - Sélection Push/Pull

MANUAL PULL MODE



Manual/Automatic selection - Sélection Manuel/Automatique

OPENING CONTROL

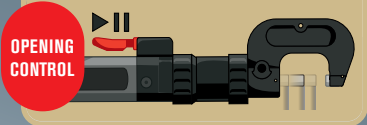

Pressure control - Contrôle de la pression - Druckregelung



Speed control - Contrôle de la vitesse - Regelung Werkzeuggeschwindigkeit

MADE IN FRANCE	AIR BAR	PRESSURE CONTROL	SPEED CONTROL	↕	⚖	🧳
				cm	kg	kg
GYSPRESS 10T PREMIUM PUSH PULL	6.5 bar = 10 t (maxi 10 bar)	0 > 6.5 bar	↔	39.5 x 180	6.7 (HR110 included)	59 x 50 x 16 / 13.1



GYPRESS

SYNERGIC RIVETING WORKSTATION

PNEUMATIC HYDRAULIC



ACCESSIBILITY

16 languages

- FR PR CN
- GB CZ JP
- DE NL VN
- IT SE FI
- ES RU TR

★★★★ SYNERGIC RIVETS SETTINGS

Main panel



3 MODES

- MANUAL
- SYNERGIC
- CAR MANUFACTURERS

CAR MANUFACTURERS COMPATIBILITY

- ✓ VW GROUP
- ✓ MERCEDES-BENZ
- ✓ BMW
- ✓ TESLA
- ✓ FERRARI
- ✓ FORD
- ✓ RENAULT ALPINE
- ✓ GM

CONNECTIVITY

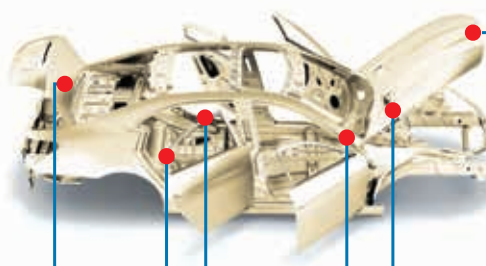

TRACEABILITY

History data export

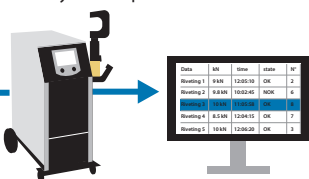

SOFTWARE UPDATE

Gyspress evolutions

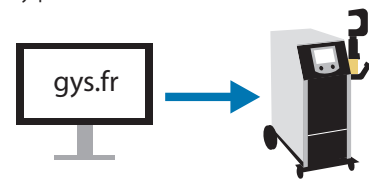

PUSH PULL SYSTEM by GYS

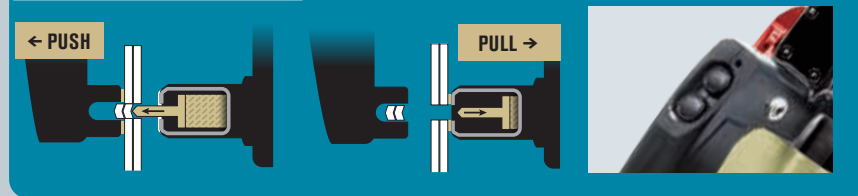

Gyspress support



Arms support



POWER 10t

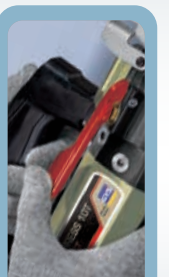

Discharge lever - Levier de décharge - Auslösehebel

WORKSTATION GYPRESS 10T PP CONTROL

6.5 bar 100 kN
10t

063860

included



OPTIONS

Pressure gauge - Capteur d'effort 10T PP CONTROL 071759



Youtube

Hydraulic body wrenches for GYPRESS 10T, 10T PushPull, 10T PP CONTROL (x2) 067325



MADE IN FRANCE WORKSTATION GYPRESS 10T PP CONTROL	230 V	AIR BAR 6.5 bar = 10 t (maxi 10 bar)	PRESSURE CONTROL 0 > 6.5 bar	SPEED CONTROL + -	↕	📦
					LxWxH cm / kg 74 x 50 x 116 / 54	LxWxH cm / kg 76 x 42 x 94 / 64.4

SYNERGIC RIVETING GYPRESS CONTROL



**BLIND RIVET ADAPTERS
- ADAPTATEURS POUR RIVETS AVEUGLES**

GYPESPRESS

Adaptators

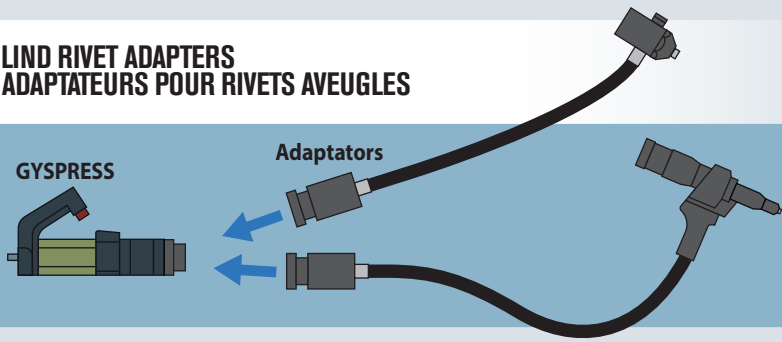

Compatibility

- GYPESPRESS 10T
- GYPESPRESS 10T PUSH PULL
- GYPESPRESS 10T PUSH PULL PREMIUM
- GYPESPRESS 10T CONNECT



Youtube

BLIND RIVET ADAPTER 24 kN - Adaptateur 24 kn pour rivets aveugles - Blindnietadapter 24 kN

24 kN STANDARD 600 mm
063822

Pour rivets POP - For BLIND rivets - Für Blindniet
Acier / Steel : Ø 4.0 → 6.4
Alu: Ø 4.0 → 7.8

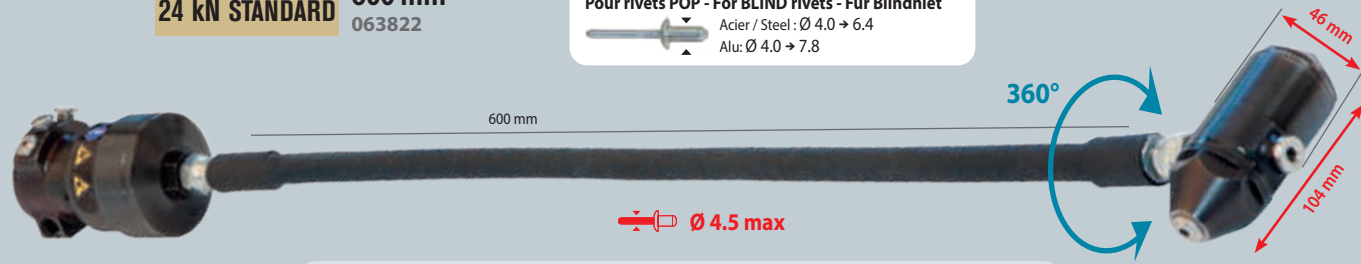

INCLUDED

- 058446
- for standard rivets: Ø 3.2 x1 059221, Ø 3.6 x1 059238
- Ø 4.0 x1 059245, Ø 4.5 x1 059252

24 kN COMPACT 600 mm
077164

Pour rivets POP - For BLIND rivets - Für Blindniet
Acier / Steel : Ø 6.4
Alu: Ø 6.4 → 7.8

COMPACT HEAD

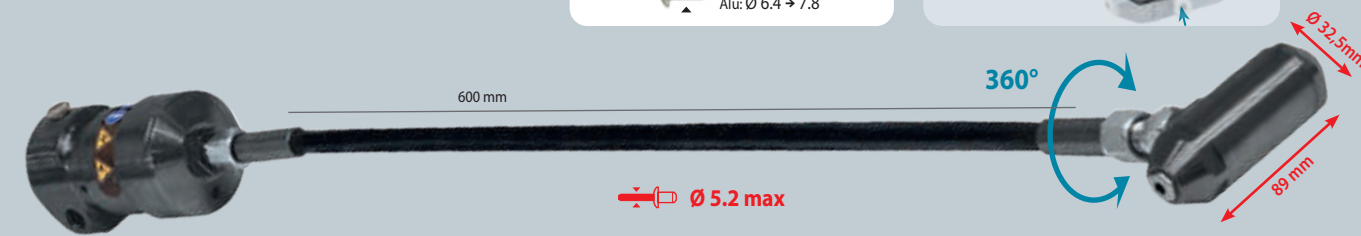

INCLUDED

- 058446
- for standard rivets: Ø 4.5 x1 081222, Ø 5.2 x1 079939

OPTION

- for extraction of self piercing rivet: Rivet-extraction insert - Buse d'extraction 24kN compact Ø 5 079946

HIGH ACCESSIBILITY



SPECIFIC STORAGE



PERFECT COMBO WITH ARCPULL

SPECIAL TEARING RIVETS
- Spécial arrachage de rivets
- Spezial-Zugnieten

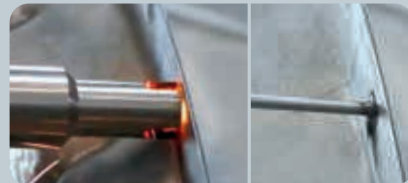
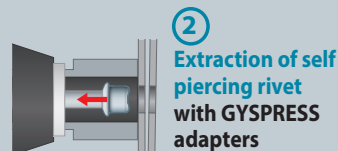
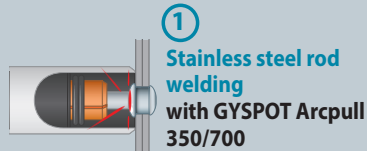

OPTION FOR GYSPOT ARCPULL (details p.17)

for GYSPOT ARCPULL 350

ARC PULL RIVET BOX1 350 - 24kN 064584					
Stainless steel nail - Tige inox Ø 4 x 50 mm 064607	Barrel for stainless steel nail welding - Canon pour pose de tige inox 059634	Mandrel support - Support porte-goujon 059634	Nozzle + pad - Buse + patin 059641	mandrel Ø4mm 049000	Buse d'extraction 24kN Ø 4 064683
x100	x1	x1	x1	x1	x1

BLIND RIVET ADAPTER 50 kN - Adaptateur 50 kn pour rivets aveugles - Blindnietadapter 50 kN



Stroke adjustment - Réglage de la course de traction
0 → 25 mm

50 kN 1 m
064867
4.0 kg

For BLIND rivets - Pour rivets POP - Für Blindniet

Steel / Acier : Ø 4.0 → 6.4
Alu: Ø 4.0 → 7.8

INCLUDED

Kit Standard



Complete kit 065987



OPTIONS

Steel / Acier : Ø 4.0 → 6.4
Alu: Ø 4.0 → 7.8

160 mm extension - Extension 160 mm - Verlängerung 160 mm
066144



Ø 8.0 → 9.8

Ø8.0/9.8mm nozzle-piece kit - Kit Rivets Ø8.0/9.8mm - Mundstückkit 8,0/9,8 mm
066045



M5 → M14
M5 → M8

Blind rivet nut pulling, Blind rivet bolt adapter kit - Kit 6 tirants pour pose d'écrous à sertir et goujons à sertir - Blindnietmuttern, Blindnietgewindebolzen-Kit
066076



OPTION FOR GYSPOT ARCPULL (details p.17)

for GYSPOT ARCPULL 350

ARCPULL RIVET BOX2 350 - 50kN 073388				
Ø 5 x 50 mm 070745	Long barrel + mandrel M5 - Canon long + mandrin M5 070738	Mandrel support - Support porte-goujon 059634	Buse + pad 059641	Buse d'extraction 50kN Ø 5 066151
x100	x1	x1	x1	x1

for GYSPOT ARCPULL 700

ARCPULL RIVET BOX 700 068452									
Ø 5 x 50 mm 070745	Long barrel + mandrel M5 - Canon long + mandrin M5 070738	Buse d'extraction 50kN Ø 5 066151	Mandrel support - Support porte-goujon 071377	Buse + pad 059641	Ring holder 059610	Rod for pulling rings - Fourche pour anneau 071384	Vis de butée 071384	Rod for pulling rings - Fourche pour anneau 071384	Vis de butée 071384
x100	x1	x1	x1	x1	x2	x1	x1	x1	x1

CONSUMABLES BOX FOR 50KN ADAPTER - Boîte consommables pour adaptateur 50kN - Zubehörbox für 50 kN Adapter

066168					
Blind rivet nuts - Écrous à sertir	Blind rivet bolts - Goujons à sertir	Blind rivets - Rivets aveugles	Blind rivet nuts - Écrous à sertir	Blind rivet bolts - Goujons à sertir	Blind rivets - Rivets aveugles
M5, M6, M8, M10, M12, M14	M5, M6, M8	Ø 6.4, Ø 9.8	M5, M6, M8	M5, M6, M8	Ø 6.4, Ø 9.8
0.5 → 3.0, 0.5 → 3.0, 0.5 → 3.0, 1.0 → 3.5, 1.0 → 4.0, 4.5 → 6.0	22.5 → 27, 24 → 28.5, 23.5 → 28	2.8 → 4.8, 3.0 → 14.0	0.5 → 3.0, 0.5 → 3.0, 0.5 → 3.0	0.5 → 3.0, 0.5 → 3.0, 0.5 → 3.0	0.5 → 3.0, 0.5 → 3.0, 0.5 → 3.0
x50 066175, x50 066182, x50 066199, x50 066205, x50 066212, x10 066229	X50 066236, X50 066243, X50 066250	x50 066267, x50 066274	X50 066236, X50 066243, X50 066250	X50 066236, X50 066243, X50 066250	x50 066236, x50 066243, x50 066250
+ demo metal sheet - plaque de démonstration	+ x10 x10 x10 x10 x10 x5	+ x10 x10 x10	+ x10 x10 x10	+ x10 x10 x10	+ x10 x10

DIES - Matrices - Matrizen

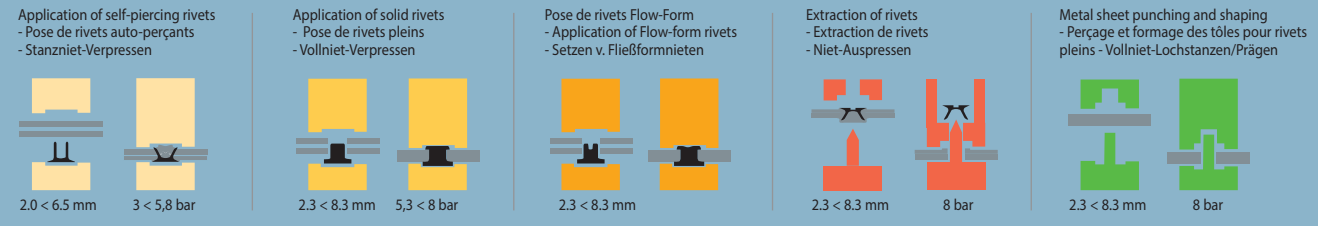

Ø 8																				
A1	A2	B1	B2	B3	B4	B5	B6	D1	D2	D3	D4	D5	D6	D7	D8	D9	D10	D11	D12	D13
055698	055704	055711	055728	055735	059016	059023	059030	055971	055988	055995	055742	056008	056015	056022	056039	056046	055674	056060	056053	055759
A1+A2		B1+B2																		
054295		054301																		

D15	D16	D17	D18	E1		E2	E3	E6	E7	E9	E10	E11	E12	E13	F1	F2	F3	F4	F45						
056077	056084	055681	071155	055865	054288	055766	057005	057142	057159	058606	058613	058620	058828	059085	055773	055780	055797	055803	083547						
				E1+E2																		F1+F2			
				054318																		054714			

F5	F6	G1	G2	G3	G4	G5	G6	H1	H2	H3	H4	H5	H6	H7	H8	I1	I2	I3	J1	J2
055810	071148	057173	057180	057197	057203	057210	057227	068230	068247	068254	068261	068278	068285	068292	068308	071117	071124	071131	071674	071902

Ø 6													Ø 6		Ø 6			Ø 8		Ø 6.7	
S1	S3	S4	S5	S7	S8	ST1	ST2	ST3	T1	T2	T3	T4	T5	T7	T8	T10	T12	T13			
057036	057043	057050	057067	057074	057081	058071	058088	066397	057098	059078	057104	055827	055834	058019	058033	058040	058064	066373	066380		
													T1+T2								
													054707								

BREVET GYS / GYS PATENT n° US 11,712,732

Ø 6.7		Ø 6		Ø 8		Ø 10									
T14	T15	T16	T17	T18	T19	T20	T21	T22	T23	T24	T25				
066410	066427	068964	066434	069312	069329	071254	069336	070936	070943	071261	070950	082830	082847	082861	082854

SELF PIERCING RIVETS (SPR)
- Rivets auto-perçants (RAP) - Stanznieten

Steel - Acier - Stahl

Complete box 048706

Ø 3,3 x 3,5 mm x 50	Ø 3,3 x 4 mm x 50	Ø 5,3 x 4 mm x 50	Ø 5,3 x 5 mm x 50	Ø 5,3 x 6 mm x 50	Ø 5,3 x 8 mm x 50	Ø 5,3 x 7 mm	Ø 5,3 x 9 mm
x200 048232	x200 048249	x100 048256	x100 048263	x100 048270	x100 048225	x100 048638	x100 048645

SPECIAL CENTER PUNCH
- Pointeau centreur - Spezialkörner

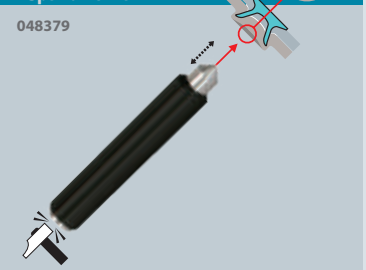

HYDROPNEUMATIC TOOL FOR BLIND RIVETS
- Riveteuse hydro-pneumatique - Hydro-pneum. Blindnietgerät

For BLIND rivets - Pour rivets POP - Für Blindniet
 Steel → 6.4 mm
 Alu → 7.8 mm
 Ø 4.0 → 7.8

HR21
max 21 000 N (6 bar)
055407

MADE IN ITALY

included (x3) 058446

For standard rivets Ø 4.0 51508

For Magnarive rivets Ø 4.5 51507

Option HR21 extension 100 mm 063105

CORDLESS RIVETER - Riveteuse sur batterie
- Akku-Blindnietgerät

For BLIND rivets - Pour rivets POP - Für Blindniet
 Ø 4.0/4.8/5.0/6.0/6.4

TWO ER20
max 20 000 N (6 bar)
10-20 V universal fast charger (30 min)
2.0 kg
064461

BRUSHLESS motor

2 x 20V/2Ah Li-ion battery

HYDROPNEUMATIC TOOL FOR BLIND RIVETS
hydro-pneumatique - Hydro-pneum. Blindnietgerät

For BLIND rivets - Pour rivets POP - Für Blindniet
 Steel / Acier Ø 4.0/4.8/6.4
 Alu Ø 4.0/4.8/6.4

HR14
max 14 000 N
057241

Made in Taiwan

MANUAL TOOL FOR BLIND RIVETS
- Riveteuse manuelle - Manueller Blindnietgerät

For BLIND rivets - Pour rivets POP - Für Blindniet
 Steel / Acier Ø 3.2/4.0/4.8/6.4
 Alu Ø 3.2/4.0/4.8/6.4

061323
Made in Taiwan

HYDROPNEUMATIC TOOL FOR RIVET NUTS
hydro-pneumatique riv 998 - Hydro-pneum. Blindnietmuttergerät

Sealing nuts - Ecrous à sertir - Blindnietmuttern

RIV 998

For sealing nuts from M3 to M12
 Pour la pose d'écrous à sertir M3 à M12

max 19 000 N (6 bar)
 included accessories for sealing nuts:
 - livré avec accessoires pour écrous à sertir:

- ✓ M3 ✓ M4
- ✓ M5 ✓ M6
- ✓ M8 ✓ M10
- ✓ M12

055414

MADE IN ITALY

HYDROPNEUMATIC TOOL FOR BLIND RIVETS
- Riveteuse hydro-pneumatique - Hydro-pneum. Blindnietgerät

For BLIND rivets - Pour rivets POP - Für Blindniet
 Steel / Acier Ø 3.2/4.0/4.8
 Alu Ø 3.2/4.0/4.8

HR9
max 9 000 N
057234

Made in Taiwan



MIG-MAG

GMAW-FCAW

TRADITIONAL

GYS AUTO	86
----------	----

INVERTER

E GYS AUTO	88
------------	----

P GYS AUTO	90
------------	----

AUTOPULSE	92
-----------	----

ACCESSORIES & CONSUMABLES	96
---------------------------	----

NEW



MIG/MAG TRADITIONAL SYNERGIC

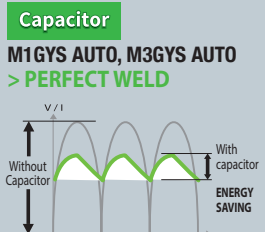

SYNERGIC EASY TO USE
Auto adaptative wire speed
- Réglage automatique de la vitesse
- Automatische Einstellung der Drahtgeschwindigkeit

M1 GYS AUTO

15 → 160 A Capacitor
230V • 1~
032903
208/240V • 1~
032088

with accessories

T1 GYS AUTO DV

15 → 200 A
400V • 3~ / 230V • 3~
032927

with accessories

M3 GYS AUTO

15 → 160 A Capacitor
230V • 1~
032880

with accessories

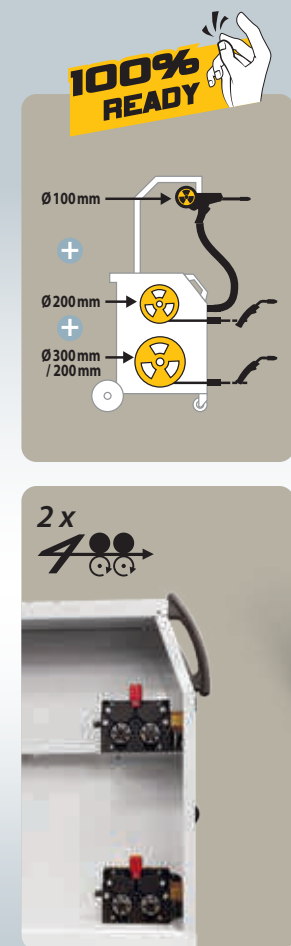

Protection gas
Argon+CO₂ (Steel, Inox)
Argon (ALU/CuSi3/CuAl8)
CO₂PUR (Steel)

Spool Gun Torch - Torche motorisée Spool Gun - Spool Gun Brenner



SPOOL GUN + Support for M3 GYS AUTO



- 15L/min (FR) 041998 (UK) 040274 (NL) 040267 (IT) 038691
- OPTIMAPRO 30L/min (FR) 043619 (UK) 043626 (DE) 043633 (NL) 043640
- 30L/min (FR) 041622 (UK) 041646 (DE) 041219 (NL) 041615 (IT) 038707
- MB 15 (150A) 041226
- x3 (M6-Ø0,6)
- x5 (M6-Ø0,8)
- x3 (Alu - M6-Ø0,8)



MADE IN FRANCE	MADE IN GYS CHINA	CE MARKING 60974/1	50/60 Hz	A	min → max	Reg	Ø mm			Electronic Control	EN60974-1 (40°C)		Ø mm	Original equipment	Protected & compatible power generator (+/-15%)		
							100 (spoolgun)	200	300		IA (60%)	X% (I2 max)				LxWxH cm / kg	
			230V 1~	16	15 → 160	6	option	▪	▪	400	90	140A@15%	0.6+1	0.6/0.8	0.8	78 x 38 x 67 / 56	4,5 kVA
			208/240V 1~							400						37 x 79 x 67 / 57.5	
			230V 3~/400V 3~	10	15 → 200	7	option	▪	▪	400	110	150A@25%	0.6+1	0.6/0.8	0.8	37 x 78 x 67 / 62	5,2 kVA
			230V 1~	16	15 → 160	6		▪	▪	400	90	140A@15%	0.6+1	0.6/0.8 0.8/1.0	2 x 0.8	74 x 40 x 85 / 77.5	4,5 kVA



MIG/MAG INVERTER SYNERGIC

Lastest generation
colour screen 3.5"

16 languages

- French
- English
- German
- Italian
- Spanish
- Portuguese
- Czech
- Polish
- Dutch
- Swedish
- Russian
- Chinese
- Japanese
- Vietnamese
- Finnish
- Turkish

EASY



EXPERT

Pre-gas / Creep speed/ Hotstart /
Crater filler / Burnback / Post-gas

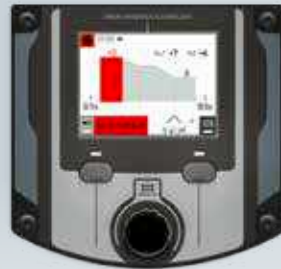

EASY TO SETUP



Screen protection -
Protection d'écran -
Bildschirmschutz
079885

MODES

- MANUAL
- SYNERGIC EASY / EXPERT
- 2T
- 4T
- SPOT
- DELAY

FONCTIONS

- TRACEABILITY
- PORTABILITY
- +500 JOBS can be saved

SYNERGIES

- STEEL
- AlSi
- AlMg
- Cu Si 3 / CuAl 8
- CrNi

UPDATES

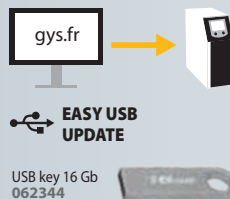

USB key 16 Gb
062344

E1 GYS AUTO

10 **200 A** 230V 1~ PFC

with accessories :

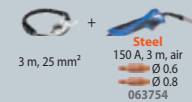

075122

E2 GYS AUTO

10 **200 A** 230V 1~ PFC

with accessories :

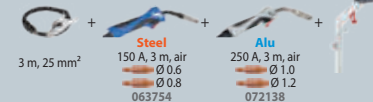

075139

E3 GYS AUTO

10 **200 A** 230V 1~ PFC

with accessories :



075160



4 m³
(20L)

1 x

6 m

	E1 GYS AUTO	E2 GYS AUTO	E3 GYS AUTO
1	Ø 200 / 300	Ø 200	Ø 200
2	-	Ø 200 / 300	Ø 200
3	-	-	Ø 200

10 → 200 A
Ideal 0.6 mm

PFC POWER FACTOR CORRECTION

195 V ← 265 V

45 m

Cable support E2/E3
077300

Helmet not included

Helmet not included

2 x 4 m³
(20L)

2 x

6 m

3 x

6 m

E1 GYS AUTO 200 A • × 1

E2 GYS AUTO 200 A • × 2

E3 GYS AUTO 200 A • × 3

MADE IN FRANCE	CE NORM. 60974/1	50/60 Hz	A	6 m	min → max A	Ø mm		Electronic Control	EN60974-1 (40°C)		Original equipment Equipement d'origine Originalausstattung Equipamiento de fabrica	LxWxH cm / kg	Protected & compatible power generator (+/-15%)	
						200	300		IA (60%)	X% (I2 max)				
▪	E1 GYS AUTO	230V 1~	16	6 m	10 → 200	▪	▪		145	200 A @ 20%	0.6 → 1	Acier Type B 0.6/0.8	79 x 37 67 / 42.6	9KVA
▪	E2 GYS AUTO	230V 1~	16	6 m	10 → 200	▪	▪		145	200 A @ 20%	0.6 → 1	Acier Type B 0.6/0.8 Alu Type B 0.8/1	72 x 37 x 105 / 59.5	9KVA
▪	E3 GYS AUTO	230V 1~	16	6 m	10 → 200	▪	▪		145	200 A @ 20%	0.6 → 1	Acier Type B 0.6/0.8 Acier Type B 0.8/1 Alu Type B 0.8/1	73 x 38 x 108 / 64	9KVA



MIG/MAG PULSE SYNERGIC

NEW

16 languages

- French
- English
- German
- Italian
- Spanish
- Portuguese
- Czech
- Polish
- Dutch
- Swedish
- Russian
- Chinese
- Japanese
- Vietnamese
- Finnish
- Turkish

Lastest generation colour screen 3.5"

EASY



EXPERT

Pre-gas / Creep speed/ Hotstart / Crater filler / Burnback / Post-gas



EASY TO SETUP



Screen protection - Protection d'écran - Bildschirmschutz 079885

MODES

EASY

- SYNERGIC STANDARD
- SYNERGIC PULSE

EXPERT

- MANUAL
- SYNERGIC STANDARD
- SYNERGIC PULSE

TORCH

2T

4T

SPOT

SPOT DELAY

FONCTIONS

TRACEABILITY

PORTABILITY

+500 JOBS can be saved

SYNERGIES

STEEL - ACIER

ALU

STAINLESS STEEL - INOX

BRAZING - BRASAGE

+40 SYNERGIES

UPDATES



EASY USB UPDATE

USB key 16 Gb 062344

10 → 220 A
Ideal 0.6 mm

P1 GYS AUTO

10 → 220 A 230V 1~ PFC

with accessories :

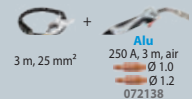

080584

P1 GYS AUTO 208-240V

10 → 220 A 208>240V 1~ PFC

with accessories :

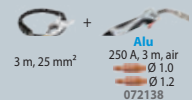

080911



1 x

P1 GYS AUTO 220 A • × 1

P2 GYS AUTO

10 → 220 A 230V 1~ PFC

with accessories :

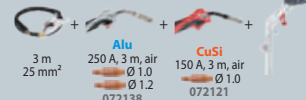

083134

P2 GYS AUTO 208-240V

10 → 220 A 208>240V 1~ PFC

with accessories :

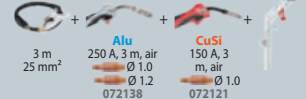

083189



2 x

P2 GYS AUTO 220 A • × 2

P3 GYS AUTO

10 → 220 A 230V 1~ PFC

with accessories :

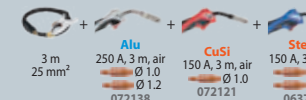

080591

P3 GYS AUTO 208-240V

10 → 220 A 208>240V 1~ PFC

with accessories :

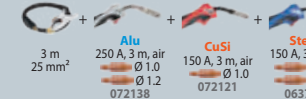

080928

Cable support P2/P3 077300



3 x

P3 GYS AUTO 220 A • × 3

MADE IN FRANCE	CE NORM. 60974/1	50/60 Hz	A	6m	min → max	A	200	300	Electronic Control	EN60974-1 (40°C)		Ø mm	Original equipment / Equipement d'origine / Originalausstattung / Equipamiento de fabrica			LxWxH cm / kg	Protected & compatible power generator (+/-15%)
										IA (60%)	X% (I2 max)		Alu Type B 1.0/1.2	Steel Type B 0.8/1.0	Steel Type B 0.6/0.8		
▪	P1 GYS AUTO	230V 1~	16		10 → 220	▪	▪	1 x	150	220 A @ 20 %	0.6 → 1.2	Alu Type B 1.0/1.2			78 x 45 x 80 / 45	9KVA	
▪	P1 GYS AUTO 208-240V	208 > 240V 1~	16	6m	10 → 220	▪	▪	1 x	150	220 A @ 20 %	0.6 → 1.2	Alu Type B 1.0/1.2			78 x 45 x 80 / -	9KVA	
▪	P2 GYS AUTO	230V 1~	16		10 → 220	▪	▪	2 x	150	220 A @ 20 %	0.6 → 1.2	Alu Type B 1.0/1.2	Steel Type B 0.8/1.0		86 x 63 x 93 / 58	9KVA	
▪	P2 GYS AUTO 208-240V	208 > 240V 1~	16	6m	10 → 220	▪	▪	2 x	150	220 A @ 20 %	0.6 → 1.2	Alu Type B 1.0/1.2	Steel Type B 0.8/1.0		86 x 63 x 93 / -	9KVA	
▪	P3 GYS AUTO	230V 1~	16		10 → 220	▪	-	3 x	150	220 A @ 20 %	0.6 → 1.2	Alu Type B 1.0/1.2	Steel Type B 0.8/1.0	Steel Type B 0.6/0.8	86 x 63 x 93 / 62	9KVA	
▪	P3 GYS AUTO 208-240V	208 > 240V 1~	16	6m	10 → 220	▪	-	3 x	150	220 A @ 20 %	0.6 → 1.2	Alu Type B 1.0/1.2	Steel Type B 0.8/1.0	Steel Type B 0.6/0.8	86 x 63 x 93 / -	9KVA	



AUTOPULSE

MIG/MAG DOUBLE PULSE SYNERGIC

Latest generation
colour screen 5"
800 x 480 (WVGA)



ACCESSIBILITY

3 interface levels

- EASY
- EXPERT
- ADVANCED

16 languages

- French
- English
- German
- Italian
- Spanish
- Portuguese
- Czech
- Polish
- Dutch
- Swedish
- Russian
- Chinese
- Japanese
- Vietnamese
- Finnish
- Turkish

EASY



3 INTERFACE LEVELS

ADVANCED
Arc length adjustments



EXPERT

Pre-gas / Hot Start / Upslope / Downslope /
Crater filler / Post-gas



500+ JOBS can be saved



TRACEABILITY



PORTABILITY



MODES

- DYNAMIC STANDARD
- PULSE
- PULSE IN PULSE
- MANUAL
- COLD PULSE

FULLY DIGITAL

4 MICROPROCESSORS



65+ SYNERGIES

Find all the synergies:
Retrouvez toutes les synergies:
Finde alle Synergien:



STEEL

Cu Si 3 / Cu Al 8

ALU

UPDATES

EASY USB UPDATE

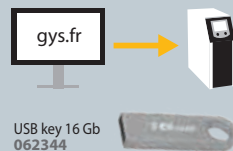

OPTIONS

PUSH PULL TORCH 24 V

MB 25
4 m
046283



Motor inside



MB 15 / MB 25
(250 A)
077089

- x5 (M6-0.6)
- x5 (M6-0.8)
- x5 (M6-0.1.0)
- x5 (Alu-M6-0.1.0)
- x5 (Alu-M6-0.1.2)

Torch gas flow-meter
- Débitmètre de
bout de torche



053939

Protection cover
- Housses de protection
- Schutzhaube
052260

AUTOPULSE 220-M1

10 220 A

230V 1~

PFC

with accessories:

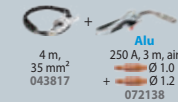

065024



AUTOPULSE 220-M1

1 220 A

230V 1~

PFC

with accessories:



069855

AUTOPULSE 220-M2

10 220 A

230V 1~

PFC

with accessories:

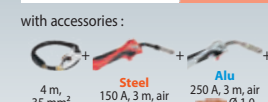

069855

AUTOPULSE 220-M2 208-240V

10 220 A

208>240V 1~

PFC

with accessories:



069862



PFC POWER FACTOR CORRECTION

185 V - 265 V



45 m

220 A • x1

220 A • x2

	MADE IN FRANCE	CE NORM. EN60974-1	50/60 Hz	A	Ø mm	A	min → max	SPOOLGUN	PUSH/PULL	200	300	Cooling system	ELECTRONIC CONTROL	IA (60%)	X% (12 max)	LxWxH cm / kg	Protected & compatible power generator (+/-15%)
AUTOPULSE 220-M1	MADE IN FRANCE	CE NORM. EN60974-1	50/60 Hz	A	Ø mm	A	min → max	SPOOLGUN	PUSH/PULL	200	300	Cooling system	ELECTRONIC CONTROL	IA (60%)	X% (12 max)	LxWxH cm / kg	Protected & compatible power generator (+/-15%)
AUTOPULSE 220-M2	MADE IN FRANCE	CE NORM. EN60974-1	50/60 Hz	A	Ø mm	A	min → max	SPOOLGUN	PUSH/PULL	200	300	Cooling system	ELECTRONIC CONTROL	IA (60%)	X% (12 max)	LxWxH cm / kg	Protected & compatible power generator (+/-15%)
AUTOPULSE 220-M2 208-240V	MADE IN FRANCE	CE NORM. EN60974-1	50/60 Hz	A	Ø mm	A	min → max	SPOOLGUN	PUSH/PULL	200	300	Cooling system	ELECTRONIC CONTROL	IA (60%)	X% (12 max)	LxWxH cm / kg	Protected & compatible power generator (+/-15%)

AUTOPULSE
INVERTER PULSE MIG 1



MIG/MAG DOUBLE PULSE SYNERGIC

BODYSHOP SPECIFIC
COLD PULSE
CuSi3 Ø 0.8/1



2 x 4 m³
(20L)

3 x

8 m

PFC POWER FACTOR CORRECTION

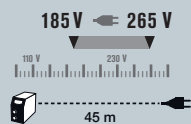

AUTOPULSE 220-M3

1				PP
2				
3				

LIC ELECTRONIC

TESLA APPROVED EQUIPMENT

10 220 A 230V 1~ PFC

with accessories:

- 4 m, 35 mm² 043817
- CuSi 150 A, 3 m, air Ø 1.0 072121
- Steel 150 A, 3 m, air Ø 0.8 063754
- Alu 250 A, 3 m, air Ø 1.0 Ø 1.2 072138

036703

10 220 A 208>240V 1~ PFC

with accessories:

- 4 m, 35 mm² 043817
- CuSi 150 A, 3 m, air Ø 1.0 072121
- Steel 150 A, 3 m, air Ø 0.8 063754
- Alu 250 A, 3 m, air Ø 1.0 Ø 1.2 072138

062481

OPTIONS

PUSH PULL TORCH 24 V

MB 25 4m 046283

Motor inside

Torch gas flow meter - Débitmètre de bout de torche 053939

MB 15 / MB 25 (250 A) 077089

Protection cover - Housse de protection - Schutzhaube 052260

- x5 (Mg-Ø 0.6)
- x5 (Mg-Ø 0.8)
- x5 (Mg-Ø 1.0)
- x5 (Mg-Ø 0.8)
- x5 (Mg-Ø 1.0)
- x5 (Alu - Mg-Ø 1.0)
- x5 (Alu - Mg-Ø 1.2)

AUTOPULSE 320-T1

1				PP
2				
3				

AUTOPULSE 320-T3

1				PP
2				
3				

AUTOPULSE 320-T3 208-240V

1				PP
2				
3				

LIC ELECTRONIC

15 320 A 400V 3~

with accessories:

- 4 m, 35 mm² 043817
- Alu 250 A, 3 m, air Ø 1.0 Ø 1.2 072138

069831



10 m³
(50L)

1 x

5 m

2 x 4 m³
(20L)

3 x

5 m

15 320 A 400V 3~

with accessories:

- 4 m, 35 mm² 043817
- Steel 250 A, 3 m, air Ø 1.0 072152
- Steel 250 A, 3 m, air Ø 0.8 072145
- Alu 250 A, 3 m, air Ø 1.0 Ø 1.2 072138

067615

15 320 A 208>240V 3~ PFC

with accessories:

- 4 m, 35 mm² 043817
- Steel 250 A, 3 m, air Ø 1.0 072152
- Steel 250 A, 3 m, air Ø 0.8 072145
- Alu 250 A, 3 m, air Ø 1.0 Ø 1.2 072138

036970

OPTIONS

for AUTOPULSE 320-T3 (400V) only

SPOOLGUN TORCH

Ideal Alu

Ø 0,8

4m 041486

Motor inside

Ø 100

220 A • x 3

320 A • x 1

320 A • x 3

MADE IN FRANCE EN60974-1	50 / 60 Hz	A	Ø mm	min → max	A	SPOOLGUN	PUSH/PULL	200	Cooling system	Equipement d'origine Original equipment Originalausstattung Equipamiento de fabrica		EN60974-1 (40°C)		LxWxH cm / kg	Protected & compatible power generator (+/-15%)
										ELECTRONIC CONTROL	IA (60%)	X% (I2 max)			
AUTOPULSE 220-M3	230 V · 1~	8 m	16	0.6+1.2	10+220	-	OPTION	■	Air		ACIER : Type B 0.6 / 0.8 ACIER : Type B 0.8 / 1.0 ALU : Type B 1.0 / 1.2	150	220 A @ 20%	75 x 41 x 94 / 80	10 kVA
AUTOPULSE 220-M3 208-240V	208>240 V · 1~	8 m	16	0.6+1.2	10+220	-	OPTION	■	Air		ACIER : Type B 0.6 / 0.8 ACIER : Type B 0.8 / 1.0 ALU : Type B 1.0 / 1.2	150	220 A @ 20%	75 x 41 x 94 / 80	10 kVA

MADE IN FRANCE EN60974-1	50 / 60 Hz	A	Ø mm	min → max	A	SPOOLGUN	PUSH/PULL	200	300	Cooling system	Original equipment Equipement d'origine Originalausstattung Equipamiento de fabrica		EN60974-1 (40°C)		LxWxH cm / kg	Protected & compatible power generator (+/-15%)
											ELECTRONIC CONTROL	IA (60%)	X% (I2 max)			
AUTOPULSE 320-T1	400 V · 3~	5 m	16	0.6+1.2	15+320	-	OPTION	■	Air		ALU : Type B 1.0 / 1.2	260	320 A @ 35%	74 x 41 x 94 / 65.1	16 kVA	
AUTOPULSE 320-T3	400 V · 3~	5 m	16	0.6+1.2	15+320	OPTION	OPTION	■	Air		ACIER : Type C 0.8 / 1.0 mm ALU : Type C 1.0 / 1.2	260	320 A @ 35%	75 x 40 x 94 / 82	16 kVA	
AUTOPULSE 320-T3 208-240V	208-240 V · 3~	5 m	25	0.6+1.2	15+320	-	OPTION	■	Air		ACIER : Type C 0.8 / 1.0 mm ALU : Type C 1.0 / 1.2	260	320 A @ 35%	74 x 41 x 95 / 82	16 kVA	

AUTOPULSE
INVERTER PULSE MIG 3

MANUAL TORCHES

- Torches manuelles - Brenner
- Antorcha - Lastoort - Tocha

CLASSIC



Flexible



CLASSIC GRIP



CONFORT GRIP
360°

FUME EXTRACTION

Fume Extraction Torches - Torches aspirantes - Rauchgas-Absaugbrenner - Antorcha con aspiración de humos



Complete systems (p. 121)



PUSH PULL

for AUTOPULSE



Light weight

Motor inside
Speed
Arc length
Select
Adjust +/-

Rollers - Galets - Drahtführungsrollen
- Rollen - Rodillos - Wielen - Roletes
0.6/0.8/1.0 046290
0.8/1.0/1.2 038752

Connector Push Pull 10 pts
064393

SPOOL GUN

Special CAR BODY REPAIR MACHINES



∅ 100



CONSUMABLES - Consommables

Gas nozzles - Buses - Düsen - Tubo - Nippel - Bicos

A		Conical nozzle - Buse conique - Konische Düse
B		Spot welding - Pointage - Punktöse
C		Nail welding - Soude clou - Nagelschweißdüse
D		Special No Gas (isolated) - Isolée spéciale Sans gaz
E		Conical nozzle - Buse conique - Konische Düse

Torch liners - Gains
- Mantel - Funda
- Drahtseelen - Folha
(p. 103)

Tip adaptors & diffusers
- Supports tube contact & diffuseurs

A1		A2	
B1		B2	
C1		C2	
D1		D2	

Contact tips - Tubes contacts
- Kontaktröhre - Tubo de contacto
- Contactbuis - Pontas de contacto

A	
B	
C	

Tip adaptors & diffusers - Supports tube contact & diffuseurs

	Steel/Stainless steel - Acier / Inox - Stahl/Edelstahl				ALU - Aluminium - Aluminio				PUSH PULL		SPOOL GUN
	AIR		LIQUID		AIR		LIQUID		AIR		AIR
	150 A	250 A	350 A	300 A	150 A	250 A	350 A	300 A	150 A	250 A	150 A
	A1 (x5) 042902	B1 (x5) 042995	D1 (x3) 043008	C1 (x3) 043589	A1 (x5) 042902	B1 (x5) 042995	D1 (x3) 043008	C1 (x3) 043589	A1 (x5) 042902	B1 (x5) 042995	A1 (x5) 042902
	A2 (x10) 042988	B2 (x5) 042919	D2 (x5) 042926	C2 (x5) 043541	A2 (x10) 042988	B2 (x5) 042919	D2 (x5) 042926	C2 (x5) 043541	A2 (x10) 042988	B2 (x5) 042919	A2 (x10) 042988

Contact tips - Tubes contacts - Kontaktröhre - Tubo de contacto - Contactbuis - Pontas de contacto

	150 A	250 A	350 A	300 A	150 A	250 A	350 A	300 A	150 A	250 A	150 A
	A (x10) 041905	A (x10) 041905	—	A (x10) 041905	—	—	—	—	—	—	—
	A (x10) 041912	B (x10) 041950	C (x10) 041790	B (x10) 041950	B (x10) 041059	A (x10) 041059	—	B (x10) 041059	B (x10) 041059	B (x10) 041059	B (x10) 041059
	A (x10) 041929	B (x10) 041967	C (x10) 419803	B (x10) 041967	B (x10) 041066	B (x10) 041066	C (x10) 419766	B (x10) 041066	B (x10) 041066	B (x10) 041066	B (x10) 041066
	A (x10) 040144	B (x10) 041974	C (x10) 419810	B (x10) 041974	B (x10) 041073	B (x10) 041073	C (x10) 419773	B (x10) 041073	B (x10) 041073	B (x10) 041073	B (x10) 041073
	—	—	C (x10) 419827	—	—	—	—	—	—	—	—
	—	—	C (x10) 419834	—	—	—	C (x10) 041080	—	—	—	—
	—	—	C (x10) 040533	—	—	—	—	—	—	—	—

Gas nozzles - Buses - Düsen - Tubo - Nippel - Bicos

	150 A	250 A	350 A	300 A	150 A	250 A	350 A	300 A	150 A	250 A	150 A		
	53 mm ∅12 (x3) 041875	57 mm ∅15 (x3) 041882	84 mm ∅16 (x3) 041783	63.5 mm ∅12 (x3) 043534	53 mm ∅12 (x3) 041875	53 mm ∅16 (x3) 046214	57 mm ∅15 (x3) 041882	84 mm ∅16 (x3) 041783	63.5 mm ∅12 (x3) 043534	63.5 mm ∅17 (x3) 046221	53 mm ∅12 (x3) 041875	57 mm ∅15 (x3) 041882	53 mm ∅12 (x3) 041875
	53 mm (x1) 041851	—	—	—	—	—	—	—	—	—	—	—	—
	53 mm (x1) 041523	—	—	—	—	—	—	—	—	—	—	—	—
	(x1) 041868	—	—	—	—	—	—	—	—	—	—	—	—
	(x1) 043084	(x1) 040571	(x1) 040588	—	—	—	—	—	—	—	—	—	—

COMPLETE TORCHES

	Steel/Stainless steel - Acier / Inox - Stahl/Edelstahl						ALU - Aluminium - Aluminio					PUSH PULL	SPOOL GUN
	AIR			LIQUID			AIR		LIQUID			AIR	AIR
	150 A	150 A	250 A	250 A	350 A	300 A	150 A	250 A	250 A	350 A	300 A	220 A	150 A
X % 40°C, ArCo ₂	150 A 60%	150 A 60%	150 A 60%	200 A 60%	290 A 60%	270 A 100%	150 A 60%	200 A 60%	230 A 60%	290 A 60%	270 A 100%	220 A 20%	150 A 60%
	A1 + A2	A1 + A2	B1 + B2	B1 + B2	D1 + D2	C1 + C2	A1 + A2	B1 + B2	B1 + B2	D1 + D2	C1 + C2	B1 + B2	A1 + A2
	M6 ∅0.8	M6 ∅1.0	M6 ∅0.8	M6 ∅1.0	M8 ∅1.2	M6 ∅1.2	M6 ∅0.8	M6 ∅1.0	M6 ∅1.2	M8 ∅1.2	M6 ∅1.2	M6 ∅1.2	M6 ∅0.8
	3 m 063754	3 m 072121	3 m 072145	3 m 072152	4 m 063792	3 m 040694	3 m 063761	3 m 063785	3 m 072138	3 m 063808	3 m 040748	4 m 046283	4 m 041486
	3 m Flexible 082151	—	—	—	4 m 063778	3 m 040687	3 m 041462	3 m 040724	—	3 m Carbon liner 040731	4 m 043282	—	—
	3 m 041424	—	—	—	3 m 040700	4 m 040946	—	—	—	4 m 040939	—	—	—
	3 m 043268	—	—	—	4 m 040922	4 m 040557	—	—	—	—	—	—	—
	3 m 043251	—	—	—	3 m 040540	—	—	—	—	—	—	—	—

Anti-spatter spray (without silicone)

- Spray protecteur sans silicone
- Antihafspray (Ohne Silicon)

041806

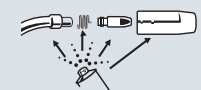

MIG torch stand with magnetic base

- Support torche magnétique

041653



Boxes

- Coffrets - Verschleißteilebox
- Cajas - Kistjes - Estojos

	x 3		x 5		M6 - ∅0.6 x 5 M6 - ∅0.8 x 5 Alu - M6 - ∅0.8 x 5		x 3	=	MB 15 (150 A) 041226
	M6 - ∅0.6 x 5 M6 - ∅0.8 x 5 Alu - M6 - ∅1.0 x 5		M6 - ∅0.8 x 5 M6 - ∅1.0 x 5 Alu - M6 - ∅1.0 x 5		—		—	=	MB 15 / MB 25 077089
	x 5		x 3		M6 - ∅0.8 x 5 M6 - ∅1.0 x 5 Alu - M6 - ∅1.0 x 5		x 3	=	MB 25 (250 A) 041233
	x 5		x 3		M6 - ∅1.0 x 5 M6 - ∅1.2 x 5 Alu - M6 - ∅1.0 x 5 Alu - M6 - ∅1.2 x 5		x 2	=	MB 36 (350 A) 041417

CONSUMABLES - Consommables

TORCH LINERS - Gainses - Mantel - Funda - Drahtseelen - Folha

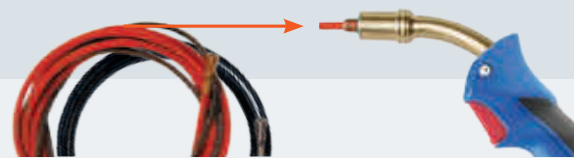

STEEL - Acier - Stahl - Acero - Staal - Aço			
Ø 0.6 / 0.8	3 m	041592	
	4 m	041837	
Ø 1.0 / 1.2	3 m	041608	
	4 m	041844	
	5 m	062276	
Ø 1.2 / 1.6	3 m	418417	
	5 m	062283	
Ø 1.6 / 2.4	4 m	040526	
	5 m	062290	

TEFLON			
Ø 0.6 / 0.8	3 m	041578	
	4 m	044050	
Ø 1.0 / 1.2	3 m	041585	
	4 m	044067	
	8 m	038677	
Ø 1.2 / 1.6	4 m	044074	



Guide gaine téflon pour motodévidoir 079601

CARBON			
Ø 0.6 / 0.8	4 m	039834	
	5 m	062306	
Ø 1.0 / 1.2	4 m	039827	
	5 m	062313	
Ø 1.2 / 1.6	4 m	039810	

PUSH PULL TORCH

Ø 1.0 / 1.2	8 m	038172
-------------	-----	--------

ROLLERS - Galets - Vorschubrollen - Rollen - Rodillos - Wielen - Roletes

TYPE A

For : Carmig



Steel, Stainless steel - Acier, Inox	Ø 0.6 / 0.8	x1	042339
	Ø 0.8 / 1.0	x1	041189
Alu	Ø 0.8 / 1.0	x1	041196
	Ø 0.8 / 0.9	x1	046856
Cored wire - Fil fourré	Ø 0.9 / 1.2	x1	042346



TYPE B

For : Autopulse 220, Autopulse 320-T1, M1 GYS Auto, M3 GYS auto, T1 GYS Auto, T3 GYS Auto, E1/E2/E3 GYS Auto



Steel, Stainless steel - Acier, Inox	Ø 0.6 / 0.8	x1	042087
	x2	042353	
Alu	Ø 0.8 / 1.0	x1	042100
	x2	042360	
Cored wire - Fil fourré	Ø 1.0 / 1.2	x1	042179
	x2	046849	
Alu	Ø 1.2 / 1.6	x2	042384
	x1	042155	
Cored wire - Fil fourré	Ø 0.8 / 1.0	x2	042377
	x1	042186	
Alu	Ø 1.0 / 1.2	x2	040915
	x2	042391	
Cored wire - Fil fourré	Ø 1.2 / 1.6	x2	042391
	x1	042131	
Alu	Ø 0.9 / 1.2	x2	042407

TYPE C

For : Neopulse - Autopulse 320-T3



Steel, Stainless steel - Acier, Inox	Ø 0.6 / 0.8	x2	041738
	Ø 0.8 / 1.0	x2	042094
Alu	Ø 1.0 / 1.2	x2	042117
	Ø 1.2 / 1.4	x2	039780
Cored wire - Fil fourré	Ø 1.2 / 1.6	x2	041752
	Ø 0.8 / 1.0	x2	042148
Alu	Ø 1.0 / 1.2	x2	042162
	Ø 1.2 / 1.6	x2	041776
Cored wire - Fil fourré	Ø 0.9 / 1.2	x2	042124

NO GAS WELDING KIT Ø 0.9 - Kit soudage sans gaz Ø 0.9

041240

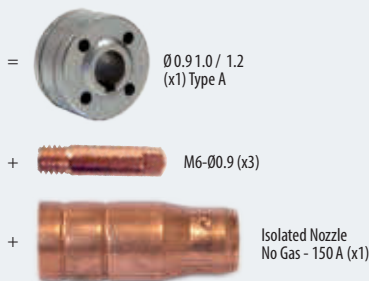

For : Easymig 150/160/160XL Smartmig 142/152/162/3P/182/183, Multiplearl 200-2

GAS CONNECTORS - Raccords gaz - Gasanschlüsse



SPECIAL MIG-MAG PLIER - Pince spéciale MIG/MAG - Spezial MIG/MAG Zange - Pinza especial MIG/MAG

PRO (x1)
041332

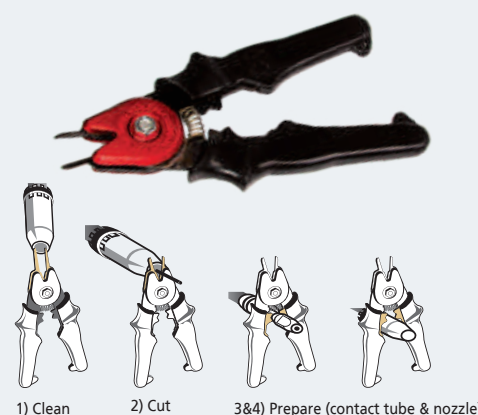

Anti-spatter spray (without silicone)
- Spray protecteur sans silicone
- Antihafspray (Ohne Silikon)

041806

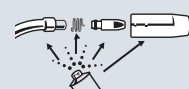

Torch gas flow-meter
- Débitmètre de bout de torche

053939



WELDING WIRE REELS - Bobines de fil - Drahtrollen - Rollos de hilo - Draadbobbijn - Bobines de fio

100 mm

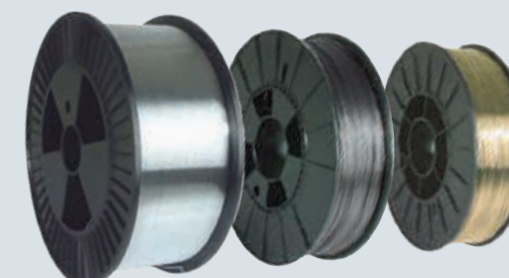

ECO
Ecological wire reel - Bobine écologique



STEEL - Acier - Stahl - Acero - Staal - Aço

SG2

Norms : AWS 5.18 : ER 70S-6 ; EN ISO 14341-A : G46 4MG3S1 ; DIN 8559 : SG2

100 mm 0.9 kg	Ø 0.6	086593
	Ø 0.8	086609
200 mm 5 kg	Ø 0.6	086111
	Ø 0.8	086128
	Ø 1.0	086135
300 mm 15 kg	Ø 0.6	086166
	Ø 0.8	086227
	Ø 0.8 ECO	086272
EXCELLIUM 15 kg	Ø 1.0	086234
	Ø 1.0 ECO	086289
	Ø 1.2	086241
EXCELLIUM 15 kg	Ø 1.2 ECO	086296
	Ø 1.0 ECO	086302
EXCELLIUM 15 kg	Ø 1.2 ECO	086319

SG1

Norms : AWS 5.18 : ER 70S-3 ; EN ISO 14341-A : G42 2MG2S1 ; DIN 8559 : SG1

200 mm 5 kg	Ø 0.6	086418
	Ø 0.8	086401

CrMO2Si

Norms : AWS 5.28 : ER 90S-B3 ; EN ISO 2195L-A : Cr CrMo2Si

300 mm 15 kg	Ø 0.8	086258
-----------------	-------	--------

UHSS

Norms : AWS ASME SFA-5.28 : ER 120 S-G ; EN ISO 12534 : G Mn4Ni2, 5CrMo

200 mm 5 kg	Ø 0.8	086203
----------------	-------	--------

Hardfacing - Rechargement Acier 60 HRC

Norms : EN 14700 : TZ Fe 2 ; DIN 8555 : MSG 6-CF-60

300 mm 16 kg	Ø 1.2 ECO	086173
-----------------	-----------	--------

Cored wire - Fil fourré - Fülldraht - Hilo tubular

Norms : AWS 5.20 : E71T-G5 ; EN ISO 17632-A T42 Z W N 1 H15

100 mm 0.9 kg	Ø 0.6	086425
	Ø 0.9	086104
200 mm 4.5 kg	Ø 0.9	086265
	Ø 1.0	086623
300 mm 15 kg	Ø 1.2	086630
	Ø 1.0	086388
	Ø 1.2	086395

Galva (G2Ti)

Norms : AWS 5.18 : ER 70S-2 ; EN ISO 14341-A : G42 2 M G2Ti ; DIN 8559 : SG2

200 mm 5 kg	Ø 0.6	086760
	Ø 0.8	086777

BRAZING - Brasage

CuAl8 HLE - UHTS (Boron Steel)

Norms : AWS 5.7 : ER CuAl-A1 ; EN ISO 14640 : S Cu 6100 ; DIN 1733 : SG-CuAl8

200 mm 2 kg	Ø 0.8	077409
200 mm 5 kg	Ø 0.8	086661
	Ø 1.0	086197
300 mm 15 kg	Ø 1.0	086180

CuSi3 HLE - UHTS (Boron Steel)

Norms : AWS 5.7 : ER CuSi-A ; EN ISO 14640 : S Cu 6560 ; DIN 1733 : SG-CuSi3

100 mm 1 kg	Ø 0.8	086692
200 mm 2 kg	Ø 0.8	077393
200 mm 5 kg	Ø 0.8	086647
	Ø 1.0	086654
EXCELLIUM 5 kg	Ø 0.8	086210

STAINLESS STEEL - Inox - Edelstahl

CrNi (316LSi)

Norms : AWS 5.9 : ER 316L Si ; EN ISO 14343-A : G19 12 3 L Si ; DIN 8556 : SG X2 CrNiMo 19 12

200 mm 5 kg	Ø 0.8	086326
	Ø 1.0	086364
300 mm 15 kg	Ø 1.0	086371

CrNi (308LSi)

Norms : AWS 5.9 : ER 308L Si ; EN ISO 14343-A : G19 9 L Si ; DIN 8556 : SG X2CrNi 19 9

100 mm 1 kg	Ø 0.8	086616
200 mm 5 kg	Ø 0.8	086579
	Ø 1.0	086340
300 mm 15 kg	Ø 1.0	086357

ALUMINIUM

AlSi5

Norms : AWS 5.10 : ER 4043 ; EN ISO 18273 : S Al 4043-A ; DIN 1732 : SG-AlSi5

100 mm 0.5 kg	Ø 0.8	086685
200 mm 2 kg	Ø 1.0	086142
	Ø 1.2	086159

AlSi12

Norms : AWS 5.10 : ER 4047 ; EN ISO 18273 : S Al 4047 ; DIN 1732 : SG-AlSi12

100 mm 0.5 kg	Ø 0.8	086678
200 mm 2 kg	Ø 0.8	077140
	Ø 1.0	086067
300 mm 7 kg	Ø 1.2	086074
	Ø 1.2	086043

AlSi10Cu4

Norms : AWS 5.10 : ER 4145 ; EN ISO 18273 : S Al 41

200 mm 2 kg	Ø 1.2	073432
----------------	-------	--------

AlMg5

Norms : AWS 5.10 : ER 5356 ; EN ISO 18273 : S Al 5356 ; DIN 1732 : SG-AlMg5

100 mm 0.5 kg	Ø 0.8	086548
200 mm 2 kg	Ø 0.8	086555
	Ø 1.0	086562
300 mm 7 kg	Ø 1.0	086524
	Ø 1.2	086531
EXCELLIUM 7 kg	Ø 1.0 ECO	086487
	Ø 1.2 ECO	086494

After sales

Ø 200 & 300



Professional 71608

Ø 200 & 300



Industrial 71613

AlMg2.7Mn

Norms : AWS 5.10 : ER 5554 ; EN ISO 18273 : S Al 5554 ; DIN 1732 : SG-AlMg

200 mm 2 kg	Ø 1.2	086517
300 mm 7 kg	Ø 1.2	086500

Thickness measurement tools (x3)
- Jauges d'épaisseur (x3)
- Dickenessgeräte (x3)
071414

0.6 > 8 mm





PLASMA CUTTING

EASYCUT K	101
EASYCUT	102
CUTTER	103



PLASMA COMPRESSOR INSIDE • 1~



EASYCUT K25

230 V • 1 ~ 25 A Fe 8 mm
Al/CrNi 6 mm

P400 COMPRESSOR

TPT 25, 4 m 068087 2 m, 10 mm²
068063

COMPRESSOR COMPRESSOR INSIDE

ULTRA LIGHT & COMPACT

INTEGRATED AIR FILTER + AUTOMATIC DRAIN

PFC EN 61000-3-12 POWER FACTOR CORRECTION

EASYCUT K35 PFC

230 V • 1 ~ 35 A Fe 15 mm
Al/CrNi 10 mm

P400 PFC AD COMPRESSOR

TPT35, 4 m 080775 2 m, 10 mm²
080768

TPT35, 4 m 2 m, 10 mm² Box TPT35 080782 UNIVERSAL 800 051331
080805

OPTIONS

Consummables	Compas 040205	PLASMA 600 040298	Universal 800 051331																														
<table border="1"> <tr> <td></td> <td></td> <td></td> <td></td> <td></td> <td>Boxes - Coffrets</td> </tr> <tr> <td></td> <td>x4 040236</td> <td>x10 040212</td> <td>x2 040175</td> <td>x10 040168</td> <td>039971</td> </tr> <tr> <td>for TPT25</td> <td>x1</td> <td>x1</td> <td>x1</td> <td>x1</td> <td></td> </tr> <tr> <td></td> <td>x4 040182</td> <td>x10 080799</td> <td>x2 040175</td> <td>x10 040168</td> <td>080782</td> </tr> <tr> <td>for TPT35</td> <td>x1</td> <td>x1</td> <td>x1</td> <td>x1</td> <td></td> </tr> </table>						Boxes - Coffrets		x4 040236	x10 040212	x2 040175	x10 040168	039971	for TPT25	x1	x1	x1	x1			x4 040182	x10 080799	x2 040175	x10 040168	080782	for TPT35	x1	x1	x1	x1		<p>x1 040199</p> <p>Rmax = 670 mm</p>	<p>PLASMA 600 040298 ↓ 39 x 58 x 62 cm / 8.2 kg ⊗ 63 x 30 x 11 cm / 8.8 kg</p>	<p>Universal 800 051331 ↓ 48 x 62 x 81 cm / 17.6 kg ⊗ 81 x 52 x 15 cm / 18.1 kg</p>
					Boxes - Coffrets																												
	x4 040236	x10 040212	x2 040175	x10 040168	039971																												
for TPT25	x1	x1	x1	x1																													
	x4 040182	x10 080799	x2 040175	x10 040168	080782																												
for TPT35	x1	x1	x1	x1																													

MADE IN FRANCE CE NORM EN60974-1	50/60 Hz	A	I ₂	mm		INTEGRATED TECHNOLOGY					AIR SYSTEM			EN 60974-1 (40°C)			Protected & compatible power generator (+/-15%)		
				Coupe max Severance cut	Coupe propre Clean cut	P400	PFC	AD	IP23	COMPRESSOR	min	ideal	max	I 60%	X% I2 max	100%		LxWxH cm / kg	
EASYCUT K25	230V 1~	16	10 → 25	8	6	6	4	■	—	—	—	■	included	15 A	35%	—	53 x 31 x 48 / 19	6.5 kW	7.5 kVA
EASYCUT K35 PFC	230V 1~	16	10 → 35	15	10	10	8	■	■	■	■	■	included	26 A	30%	—	45 x 26 x 36 / 27	8 kW	10 kVA



PLASMA

1~

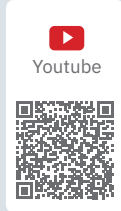

Plasma torch
TPT 25, 4m
068087

Plasma torch
TPT 35, 4m
080775

Plasma torch
TPT 40, 4m
060753

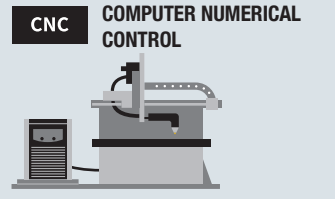
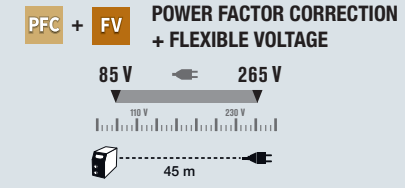
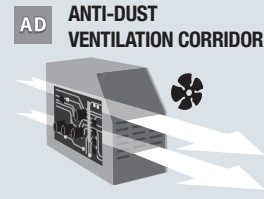

DIGITAL (PRESSURE SENSOR)

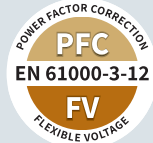

IDEAL CARBODY REPAIR

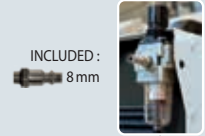

DIGITAL (PRESSURE SENSOR)

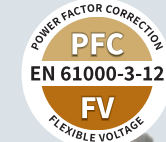

DIGITAL (PRESSURE SENSOR)



EASycut 25

230 V • 1 ~ **25 A** Fe 8 mm
Al/CrNi 6 mm

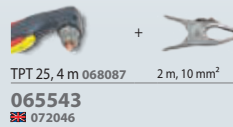

TPT 25, 4 m 068087 2 m, 10 mm²
065543
072046

EASycut 30 FV

110 → 230 V • 1 ~ **30 A** Fe 15 mm
Al/CrNi 10 mm

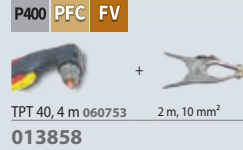

TPT 40, 4 m 060753 2 m, 10 mm²
013858

EASycut 40

230 V • 1 ~ **40 A** Fe 18 mm
Al/CrNi 15 mm

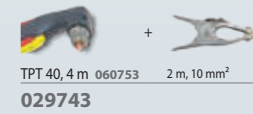

TPT 40, 4 m 060753 2 m, 10 mm²
029743

Cutter 45 CT

110 → 230 V • 1 ~ **45 A** Fe 30 mm
Al/CrNi 20 mm



MT 70, 6 m 2 m, 10 mm² Box 20-50A 061613
062962

COMPAS
for TPT 40, TPT 25, TPT 35,
MT 25K / MT 35K
x1
040199

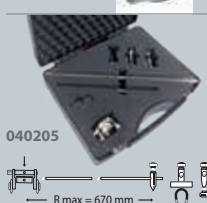

040205
R max = 670 mm

Consumables	TPT				
	MT25K	TPT25	MT35K	TPT35	TPT40
	x4 040182	x4 040236	x4 040229	x4 040182	x4 040236
	x10 040151	x10 040212	x10 040212	x10 080799	x10 040212
	x2 040175	x2 040175	x2 040175	x2 040175	x2 040175
	x10 040168	x10 040168	x10 040168	x10 040168	x10 040168
Boxes - Coffrets	039971	070721	039964	080782	039957

Trolley - Chariot	PLASMA 600	Universal 800	Jobsite XL
	040298	051331	039568
	↳ 39 x 58 x 62 cm / 8.2 kg	↳ 48 x 62 x 81 cm / 17.6 kg	↳ 60 x 59 x 115 cm / 18.4 kg
	↳ 63 x 30 x 11 cm / 8.8 kg	↳ 81 x 52 x 15 cm / 18.1 kg	↳ 66 x 47 x 20 cm / 19.6 kg

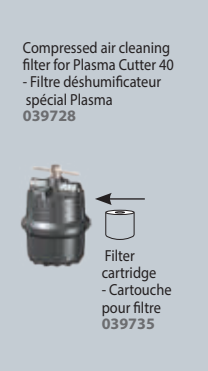

Compressed air cleaning filter for Plasma Cutter 40
- Filtre déshumificateur spécial Plasma 039728

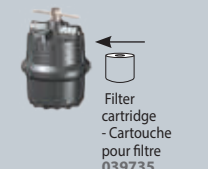

Filter cartridge - Cartouche pour filtre 039735

CE NORME EN60974-1	EASycut / CUTTER	Voltage	I ₂	mm				INTEGRATED TECHNOLOGY						AIR SYSTEM			EN 60974-1 (40°C)		LxWxH cm / kg	Protected & compatible power generator (+/-15%)										
				Coupe max Severance cut	Coupe propre Clean cut	Perçage Piercing	P400	PFC	FV	GRID CUT	AD	IP23	CNC	min	ideal	max	I 60%	X% I2 max			100%									
																						Fe	Al/CrNi	Fe	Al/CrNi	Fe	Al/CrNi	Fe	Al/CrNi	Fe
MADE IN GYS CHINA	EASycut 25	230V1~	16	10 → 25	8	6	6	4	—	—	—	—	—	—	—	—	—	—	—	—	—	—	—	—	—	—	—	—		
MADE IN FRANCE	EASycut 30FV	230V1~ 110V1~	16 32	10 → 30 10 → 30	15	10	10	8	—	—	—	—	—	—	—	—	—	—	—	—	—	—	—	—	—	—	—	—	—	
MADE IN GYS CHINA	EASycut 40	230V1~	16	10 → 40	20	15	15	10	—	—	—	—	—	—	—	—	—	—	—	—	—	—	—	—	—	—	—	—	—	
MADE IN FRANCE	Cutter 45CT	<i>TPT 40</i>	230V1~ 110V1~	16 32	15 → 45 15 → 30	20 15	15 10	10 8	8 —	6 —	—	—	—	—	—	—	—	—	—	—	—	—	—	—	—	—	—	—	—	—
		<i>MT 70</i>	230V1~ 110V1~	32 32	15 → 45 15 → 30	30 15	20 10	25 10	15 8	12 —	10 —	—	—	—	—	—	—	—	—	—	—	—	—	—	—	—	—	—	—	—



GYS

INVEST IN THE FUTURE



INDUCTION HEATING

1 200 - 22 000 kW

GYSDUCTION 106

COMBIDUCTION 107

POWERDUCTION 108

ACCESSORIES & CONSUMABLES 112



INDUCTION HEATING

CAR BODY

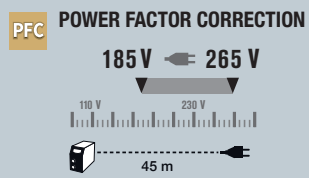

	PACKS - GYSDUCTION AUTO									
	PROLINER AUTO 048775	COMPLETE AUTO 053380	COMPLETE AUTO+ 056978	MECA AUTO 048812	MECA AUTO+ 056961	BODY SHOP AUTO 048799	GLASS AUTO 048805	DENT REPAIR AUTO 054981	SMART REPAIR AUTO 079847	
	✓	✓	✓	✓	✓	✓	✓	✓	✓	✓
	✓	✓	✓	—	—	✓	✓	—	✓	—
	✓	✓	✓	—	—	✓	✓	—	✓	—
	✓	✓	✓	—	—	✓	1 box	—	✓	—
	✓	✓	✓	✓	✓	—	—	—	—	—
	✓	✓	✓	✓	✓	✓	—	—	✓	—
	✓	1 box	—	1 box	—	—	—	—	—	—
	✓	—	—	—	—	—	—	—	—	—
	3 boxes	—	—	—	—	✓	✓	1 box	1 box	—
	—	✓	—	✓	✓	1 box	—	—	✓	1 box



GYSDUCTION AUTO

2 400 W 230 V • 1 ~

PFC AIR

CONSUMABLES



Protection (x5) + Colle - Stick 053854



Protection (x1) + Colle - Stick 059108



Protection (x10) + Colle - Stick 053847



READY TO USE
Liquid included

COMBIDUCTION AUTO 50LG

5 200 W 230 V • 1 ~

PFC LIQUID

065901



INCLUDED COMBIDUCTION

Glass - Décapage - Entfernen 053373

Decal - Décollage - Entkleben 053359

OPTIONS

Spiral inductor - Inducteur spirale - Spiralinduktor 054783

2.5 m 1.2 kW

800 mm 054813 800 mm 054868

SIDE	Ø 18 mm	⊙ ≤ M8	054806
	Ø 24 mm	⊙ ≤ M12	054790
	Ø 30 mm	⊙ ≤ M16	055469

Complete with - Complétez avec - Vervollständigen mit :

SIDE	Ø 21 mm	⊙ ≤ M10	079953
	Ø 27 mm	⊙ ≤ M14	079960
FRONT	Ø 18 mm	⊙ ≤ M8	079977
	Ø 21 mm	⊙ ≤ M10	079984
	Ø 24 mm	⊙ ≤ M12	079991
	Ø 27 mm	⊙ ≤ M14	080003
	Ø 30 mm	⊙ ≤ M16	080010

PDR : Paintless Dent Repair - Débosselage sans peinture - Lackschadenfreies Ausbeulen 054776

Licensed by BETAG innovation

3 m

Freezer spray - Spray refroidisseur -50 °C 400 ml (x 12) 048898

Adhesive for logo (x10) 051492

CE NORM. EN-60335/1	MADE IN FRANCE	Cable L (m)	Heating	LxWxH cm / kg	LxWxH cm / kg	Protected & compatible power generator (+/-15%)	Power							
							A	W						
		230V, 1~, 50/60 Hz	16 mini	2400	35 x 100	—	2	2.5	M10 → 1 s	2 mm → 5 s	Ø8 → 10 s	37 x 21 x 37 / 7.5	52 x 30 x 37 / 12.9	3 kW
		230V, 1~, 50/60 Hz	25 mini	5200	20 x 80	71	8	3	M14 → 1 s	2 mm → 3 s 4 mm → 5 s	Ø10 → 10 s	46 x 43 x 75 / 60	v	6 kW



INDUCTION HEATING

1.2 → 5.2 kW

MAINTENANCE / MECHANIC / INDUSTRY

	10R	10R PRO
POWERDUCTION 10R	✓	✓
Flexible 800 mm 054813	✓	✓
Straight 800 mm 054868	✓	✓
SIDE		
Ø 18 mm ⊙ ≤ M8 054806	✓	✓
Ø 21 mm ⊙ ≤ M10 079953	✓	✓
Ø 24 mm ⊙ ≤ M12 054790	✓	✓
Ø 27 mm ⊙ ≤ M14 079960	✓	✓
Ø 30 mm ⊙ ≤ M16 055469	✓	✓
FRONT		
Ø 18 mm ⊙ ≤ M8 079977	✓	✓
Ø 21 mm ⊙ ≤ M10 079984	✓	✓
Ø 24 mm ⊙ ≤ M12 079991	✓	✓
Ø 27 mm ⊙ ≤ M14 080003	✓	✓
Ø 30 mm ⊙ ≤ M16 080010	✓	✓



	included	NEW 37LG S90	37LG S180/ B3W
S90 058927	✓	✓	—
S180/B3W 067899	—	—	✓



1200 W | 230V • 1~ | AIR

POWERDUCTION 10R
(5 inductors)
062504
068643
080966

POWERDUCTION 10R PRO
(12 inductors)
080195
080300

POWERDUCTION 37LG (S90) | POWERDUCTION 37LG (S180/B3W)

3700 W | 230V • 1~ | * LIQUID
056992 | 080195 | 072510 | 080959

3700 W | 230V • 1~ | * LIQUID
083387 | 083394

NEW

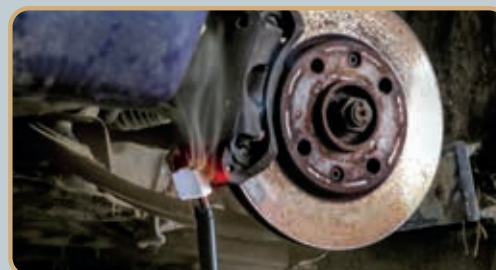

	included	39LG C20/B1	39LG S90
C20/B1 056862	✓	✓	—
28S 064485	—	—	✓
S90 058927	—	—	✓

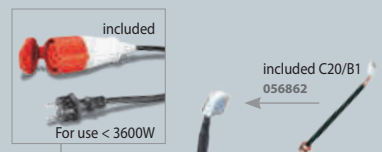

READY TO USE
Liquid included

READY TO USE
Liquid included

POWERDUCTION 39LG (C20/B1) | POWERDUCTION 39LG (S90)

3700 W | 230V • 1~ | * LIQUID
058583

3700 W | 230V • 1~ | * LIQUID
080027

POWERDUCTION 50LG

5200 W | 230V • 1~ | * LIQUID
055599

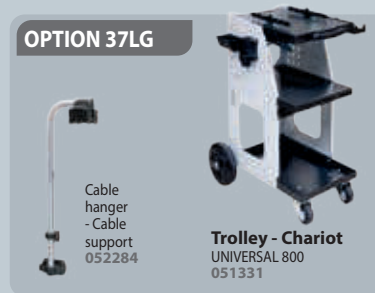
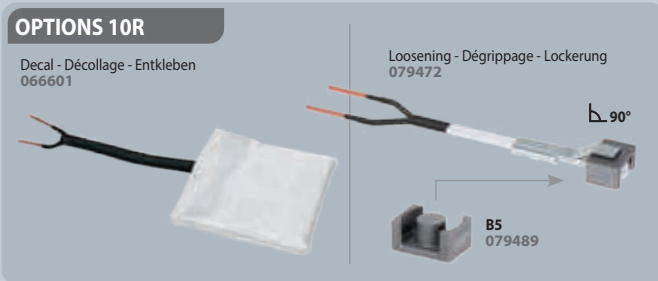

MADE IN FRANCE	A	W	kHz	INTEGRATED TECHNOLOGY		Liquid Cooling	Cable L (m)	Heating			Protected & compatible power generator (+/-15%)	L x W x H cm / kg	L x W x H cm / kg	
				P400	PFC			Inductor	Heating	Heating				
POWERDUCTION 10R / 10R PRO	230V, 1~ / 50/60 Hz	10 mini	1200	45+80	—	—	2	1.5	M10 → 1s	2 mm → 5 s	Ø8 → 10 s	1.5 kW	062504 - 42 x 17 x 37 / 5.4	062504 - 21 x 10 x 15 / 3.3
POWERDUCTION 37LG	230V, 1~ / 50/60 Hz	16 mini	3700	15+30	—	—	2	2	M10 → 1s	2 mm → 5 s	Ø10 → 15 s	4 kW	60 x 34 x 33 / 14.5	56 x 26 x 29 / 13
POWERDUCTION 39LG (C20/B1) / (S90)	230V, 1~ / 50/60 Hz	16 mini	3700	20+60	■	■	6	3	M12 → 1s	2 mm → 5 s	Ø10 → 15 s	4 kW	058583 - 81 x 38 x 59 / 52	058583 - 46 x 36 x 70 / 46.5
POWERDUCTION 50LG	230V, 1~ / 50/60 Hz	25 mini	5200	20+60	■	■	8	3	M14 → 1s	2 mm → 3 s / 4 mm → 5 s	Ø10 → 10 s	6 kW	80 x 60 x 60 / 71	46 x 43 x 75 / 58



INDUCTION HEATING 11 → 22 kW

		110LG L90	110LG L20/B4
32L	064515	✓	✓
L90	059788	✓	—
L20/B4	067882	—	✓

NEW

		160LG L90	160LG L20/B4
32L	064515	✓	✓
L90	059788	✓	—
L20/B4	067882	—	✓

NEW



READY TO USE
Liquid included



READY TO USE
Liquid included



READY TO USE
Liquid included

	POWERDUCTION 110LG (L90)		POWERDUCTION 110LG (L20/B4)
11 000 W	400 V • 3~	11 000 W	400 V • 3~
* LIQUID		* LIQUID	
058590		083400	NEW

	POWERDUCTION 110LG (L90) 208-240V
11 000 W	208-240 V • 3~
* LIQUID	
065246	

	POWERDUCTION 160LG (L90)		POWERDUCTION 160LG (L20/B4)
16 000 W	400 V • 3~	16 000 W	400 V • 3~
* LIQUID		* LIQUID	
057814		083417	NEW

	POWERDUCTION 160LG (L20/B4) 208-240 V
16 000 W	208-240 V • 3~
* LIQUID	
065253	

OPTIONS

- Removable handle - Poignée de lance - Abnehmbarer Griff for POWERDUCTION 110 - 160 - 220 LG 068599
- Cooling liquid for POWERDUCTION 2L 082212, 5L 062511, 10L 052246
- Protection cover - Housses de protection - Schutzhaube for POWERDUCTION 160 - 220 LG 050853
- Protection cover - Housses de protection - Schutzhaube for POWERDUCTION 110LG 062733
- 055490

OPTION

Powerduction 160/220 LG over hanging arm-pulley
- Équilibrer Powerduction 160/220 LG

079441

t° POWER HEAT CONTROLLER

t° CONTROL
80>350°C (210>660°F)

5,5m

POWER HEAT CONTROLLER
061644

Included
T° sensors thermocouple type K x2

Compatibility
POWERDUCTION 110LG
POWERDUCTION 110LG 208-240 V
POWERDUCTION 160LG
POWERDUCTION 160LG 208-240 V
POWERDUCTION 220LG

OPTION

Pyrometer IR for inductor L90

1.1 m
064119

MADE IN FRANCE	Cable L (m)	Freq. kHz	Liquid Cooling	Cable L (m)	Inductor	Heating		LxWxH cm / kg	LxWxH cm / kg	Protected & compatible power generator (+/-15%)			
						Power (kW)	Current (A)						
POWERDUCTION 110LG	400 V, 3~, 50/60 Hz	16 mini	11 000	20+60	71	5	4	M18 → 1 s	2 mm → 2 s 4 mm → 4 s	Ø10 → 7 s	42 x 42 x 76 / 66.5	59 x 80 x 60 / 86	15 kW
POWERDUCTION 110LG 208-240V	208-240 V, 3~, 50/60 Hz	35 mini	11 000	20+60	71	5	4	M18 → 1 s	2 mm → 2 s 4 mm → 4 s	Ø10 → 7 s	42 x 42 x 76 / 78	59 x 80 x 60 / 90	15 kW
POWERDUCTION 160LG	400 V, 3~, 50/60 Hz	32 mini	16 000	20+60	301	4	6	M20 → 1 s	2 mm → 2 s 4 mm → 4 s	Ø10 → 5 s	78 x 58 x 118 / 128	80 x 61 x 120 / 140	22 kW
POWERDUCTION 160LG 208-240V	208-240 V, 3~, 50/60 Hz	45 mini	16 000	20+60	301	4	6	M20 → 1 s	2 mm → 2 s 4 mm → 4 s	Ø10 → 5 s	78 x 58 x 118 / 113.5	80 x 60 x 120 / 126	22 kW
POWERDUCTION 220LG	400 V, 3~, 50/60 Hz	32 mini	22 000	20+60	301	4	6	M45 → 3 s	4 mm → 3 s 8 mm → 9 s	Ø10 → 4 s	70 x 60 x 120 / 98	80 x 60 x 132 / 139	22 kW
POWERDUCTION 220LG 10M	400 V, 3~, 50/60 Hz	32 mini	22 000	20+60	301	4	10	M45 → 3 s	8 mm → 9 s 4 mm → 3 s	Ø10 → 4 s	70 x 60 x 120 / 132.5	80 x 60 x 120 / 144.5	22 kW

SMALL Ø16

INDUCTORS

* = original equipment	S90 058927	S70 061569	S180 059269	S20/B1 (20°) 064874	S180/B1 064881	S180/B3W 067899
37 LG	✓*		✓			✓
39 & 50 LG			✓ with adapter 28S			
110, 160 & 220 LG			✓ with adapter 32S			

	S20/D20 078796	S90/D20 078871	S180/D20 069985
Ø 20	S20/D25 078802	S90/D25 078888	S180/D25 069992
Ø 25	S20/D30 078819	S90/D30 078895	S180/D30 070592
Ø 30	S20/D35 078826	S90/D35 078901	S180/D35 070608
Ø 35	S20/D40 078833	S90/D40 078918	S180/D40 070615
Ø 40	S20/D45 078840	S90/D45 078925	S180/D45 070622
Ø 45	S20/D50 078857	S90/D50 078932	S180/D50 070639
Ø 50	S20/D55 078864	S90/D55 078949	S180/D55 070646
Ø 55			
37 LG	✓ S20/D20-D35, S90/D20-D35, S180/D20-D35		
39 & 50 LG	✓ with adapter 28S		
110, 160 & 220 LG	✓ with adapter 32S		
Protection kit for L180/D inductors - Kit de protection pour inducteurs boucle 077386			

	S180 HEAT TUBE D37 078604	S180 HEAT TUBE D40 078611	S180 HEAT TUBE D50 078628
39 & 50 LG	✓ with adapter 28S		
110, 160 & 220 LG	✓ with adapter 32S		

DIFFICULT ACCESS ADAPTERS	
	90°-S 082663
	✓ compatible with 180/B1 ✓ compatible with 180/B2 ✓ compatible with 180/B3W

ADAPTERS	
	28S M28 Ø16 064485
	32S M32 Ø16 064508
39 & 50 LG	✓ 28S M28 Ø16
110, 160 & 220 LG	✓ 32S M32 Ø16

Boxes - Boîtes					
	28S/B type W for 39LG & 50LG 072497		32S/B type W for 110LG, 160LG & 220LG 072503		L box 065796
	included: S20/B1 (x1) S180/B1 (x1) S180/B3 (x1) 28S (x1) B1 (x1) B3 (x1)		included: S20/B1 (x1) S180/B1 (x1) S180/B3 (x1) 32S (x1) B1 (x1) B3 (x1)		included: L70 (x1) L180 (x1)

Trolley for inductor for adapter 32L Chariot pour inducteur pour adaptateur 32L 075955		4 to 8 wheels	
--	--	---------------	--

Ferrites - Ferrites - Ferritaufsatz																					
	B1 053823		B2 053458		B3 067875		B4 053755		B5 079489		B1 (x5) 079380		B1 056909		B2 056916		B3 072527		B4 054844		Spiral 069701

Glue kit for inductor Kit de colle pour inducteur 075948			EA 9487
			Colle-Stick bi-composants Power Epoxy 150°C 054851

LARGE Ø32

INDUCTORS

* = original equipment	L90 (90°) 059788	L70 (70°) 059771	L180 059795	L180/Spiral 065000	L20/B4 067882	L180/B4 079786	L20 Alu Glove 069114
39 & 50 LG	✓ with adapter 28L						
110, 160 & 220 LG	✓ with adapter 32L*		✓ with adapter 32L		✓ with adapter 32L*	✓ with adapter 32L	✓ with adapter 32L

Ø	Pre-heating - Préchauffe Heating - Chauffage	Pre-heating & Fretting - Préchauffage et Frettage		
Ø 60		L20/D60 078956	L90/D60 079106	L180/D60 069923
Ø 70		L20/D70 078963	L90/D70 079113	L180/D70 069930
Ø 80		L20/D80 078970	L90/D80 079120	L180/D80 069121
Ø 90		L20/D90 078987	L90/D90 079137	L180/D90 069947
Ø 100		L20/D100 078994	L90/D100 079144	L180/D100 069954
Ø 110	✓	L20/D110 079007	L90/D110 079151	L180/D110 069961
Ø 120	✓	L20/D120 079014	L90/D120 079168	L180/D120 069978
Ø 130	✓	L20/D130 079021	L90/D130 079175	
Ø 140		L20/D140 079038	L90/D140 079182	
Ø 150		L20/D150 079045	L90/D150 079199	
Ø 160		L20/D160 079052	L90/D160 079205	Production on request
Ø 170		L20/D170 079069	L90/D170 079212	
Ø 180		L20/D180 079076	L90/D180 079229	
Ø 190		L20/D190 079083	L90/D190 079236	
Ø 200		L20/D200 079090	L90/D200 079243	
39 & 50 LG		✓ with adapter 28L		
110, 160 & 220 LG		✓ with adapter 32L		

Pre-heating & Fretting - Préchauffage et Frettage	
> Ø 200 & < Ø 300	Production on request
110, 160 & 220 LG	✓ with adapter 32L

Brasing - Brasage	
* = original equipment	L90 BRAZ 16 Ø 1/2" / 16 mm 076907
	L90 BRAZ 28 Ø 1" / 28 mm 076921
	L180 BRAZ 16 Ø 1/2" / 16 mm 076914
	L180 BRAZ 28 Ø 1" / 28 mm 076938
110, 160 & 220 LG	✓ with adapter 32L*

Protection kit for BRAZ inductors - Kit de protection pour inducteurs brasage 077515	
--	--

Protection kit for L180/D inductors - Kit de protection pour inducteurs boucle 077386	
---	--

ADAPTERS		
	28L M28 Ø32 064492	32L M32 Ø32 064515
39 & 50 LG	✓ 28L M28 Ø32	
110, 160 & 220 LG	✓ 32L M32 Ø32	

Exchanger - Échangeur	
	L180R X Production on request
110, 160 & 220 LG	✓ with adapter 32L

COMPLETE Ø28 INDUCTORS

	C20/B1 056862	C180/B1 056879	C180/B2 056886
37 LG			
39 & 50 LG	✓*		✓
110, 160 & 220 LG			



TRUCK TOOLS & MOBILE LIFTS

TRUCK TOOLS

TROLLEY IW1	115
MULTITOOL TRUCK	115

CAR LIFTS

SPOT LIFT	116
NEW QUICK LIFT / AIR JACKS	118
ERGO LIFT	119
NEW MANUAL DOOR LIFT / WHEEL LIFT	120



TROLLEY IW1 / MULTITOOL TRUCK

TRUCK TOOLS

TROLLEY IW1
Impact wrench trolley -
Support de clé à choc

max 6.5 bar

max 20 kg

063136



Youtube

OPTIONS



Huile hydraulique
- Hydraulic oil
1l
053397

**Weight, vibrations & torque suppression -
Suppression du poids,
des vibrations et du couple**

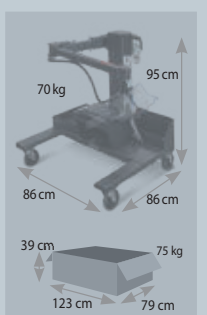

70 kg
95 cm
86 cm
86 cm
39 cm
75 kg
123 cm
79 cm

Impact wrench -
Clé à choc
max 20 kg

Fixation
36 x 36 mm
→ 44 x 44 mm

Weight adjust
- Effort réglable

**High maneuverability & stability -
Grande maniabilité et stabilité**



**High dexterity -
Liberté de mouvement**

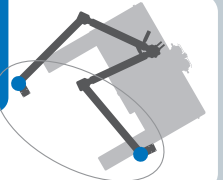

115

TRUCK TOOLS



MULTITOOL TRUCK

SAFE EN 14238 + A1

max 200 kg

067158

INCLUDED



Lifting tool for brake caliper
- Outil de levage pour étrier
de frein - Hebewerkzeug für
Bremssattel

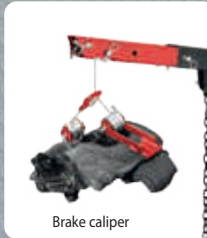

Brake caliper



Lifting tool for battery -
Outil de levage pour batterie
- Hebewerkzeug für Batterie

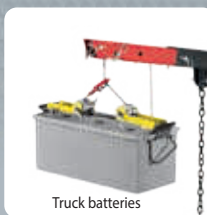

Truck batteries



Lifting tool for wheels -
Outil de levage pour roues
- Hebewerkzeug für Räder



SAFE EN 14238 + A1

ULTRA COMPACT 103 cm

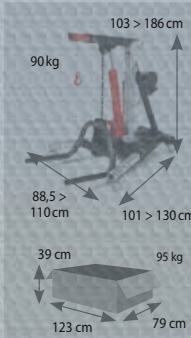

HEALTH CARE

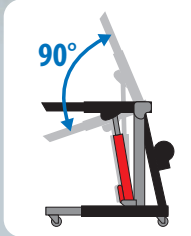
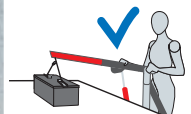



SPOT LIFT

MOBILE LIFTS

SPOT LIFT EASY

max Air 8 bar **SAFE EN 1494**
max 2.2 t

HEALTH CARE



High stability - Haute stabilité

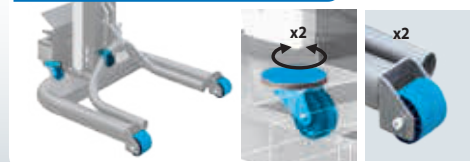

Included
220 bar
053588

SAFE EN 1494

SECURITY

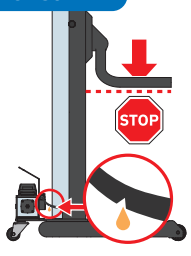

OPTIONS

Hydraulic oil 1L
- Huile hydraulique
1L
053397



Rocker panel lifting tool
- Outil de levage pour bas de caisse
- Auflage für Seitenschweller
053236



SPOT LIFT PRO

max Air 8 bar **SAFE EN 1494**
max 2.2 t

053557

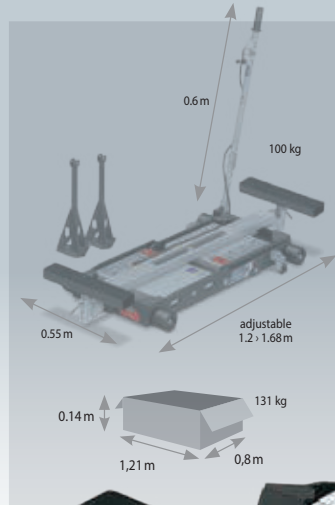

SPOT LIFT PRO MOB

max Air 8 bar **SAFE EN 1494**
max 2.2 t

055896

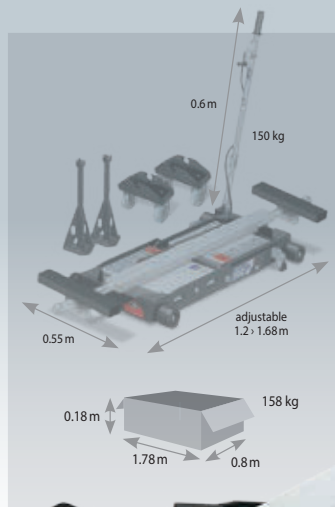

60 cm (max)
14 cm (min)

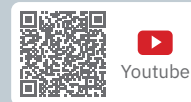

AUTO ROLL

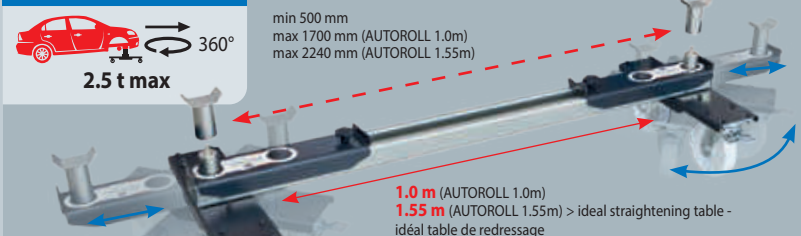

AUTO ROLL 1.0 m / 1.2 t
059047



AUTO ROLL 1.55 m / 1.2 t
063839



AFTER LIFT AUTO ROLL

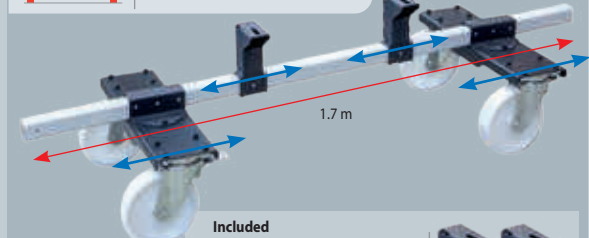
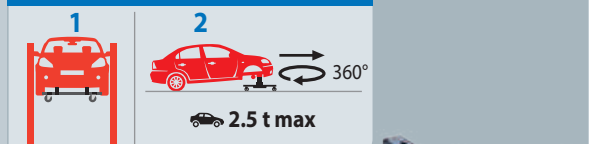

WHEEL TROLLEYS - Tabourets de manutention - Radhocker



MECHANICAL LIFTING JACKS - Chariots de manutention prise sous roue - Kfz-Montagelift, fahrbar

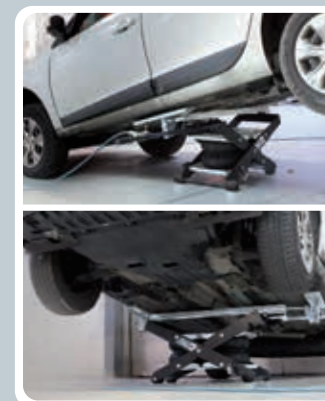
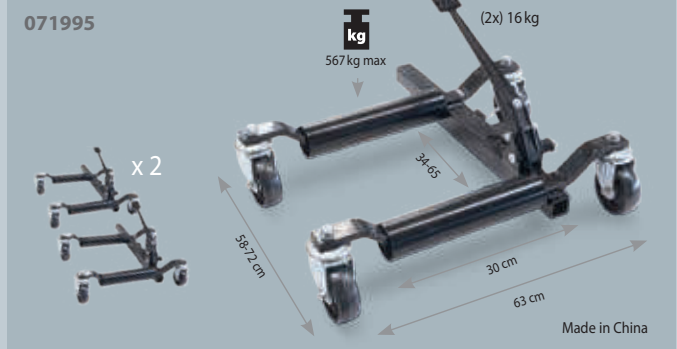

OPTIONS

Height adjuster for 4x4 & utility vehicles
- Réhausseur pour 4x4 et utilitaires
- Erhöhung f. 4x4 und Leicht-LKW



Pads - Patins for Audi & BMW (x 2)
053717

Ramps - Ramps 700 x 200 x 80 mm (x 2)
056787



OPTIONS

SPOT LIFT PRO MOB
Réhausseur pour 4x4 et utilitaires
- Height adjuster for 4x4 & utility vehicles
- Erhöhung f. 4x4 und Leicht-LKW



Patins - Pads for Audi & BMW (x 2)
061606

Ramps - Ramps 700 x 200 x 80 mm (x 2)
056787



QUICK LIFT L520E

062184

220 V, 1 ph
0.75 kW



Included
Hydraulic oil 5 L
- Huile hydraulique
5 L
062160

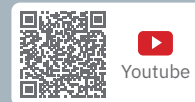

10 cm
12 cm
5 cm
Pads - Patins
Included (x 8)

SAFE
EN 1493

2.5 t max

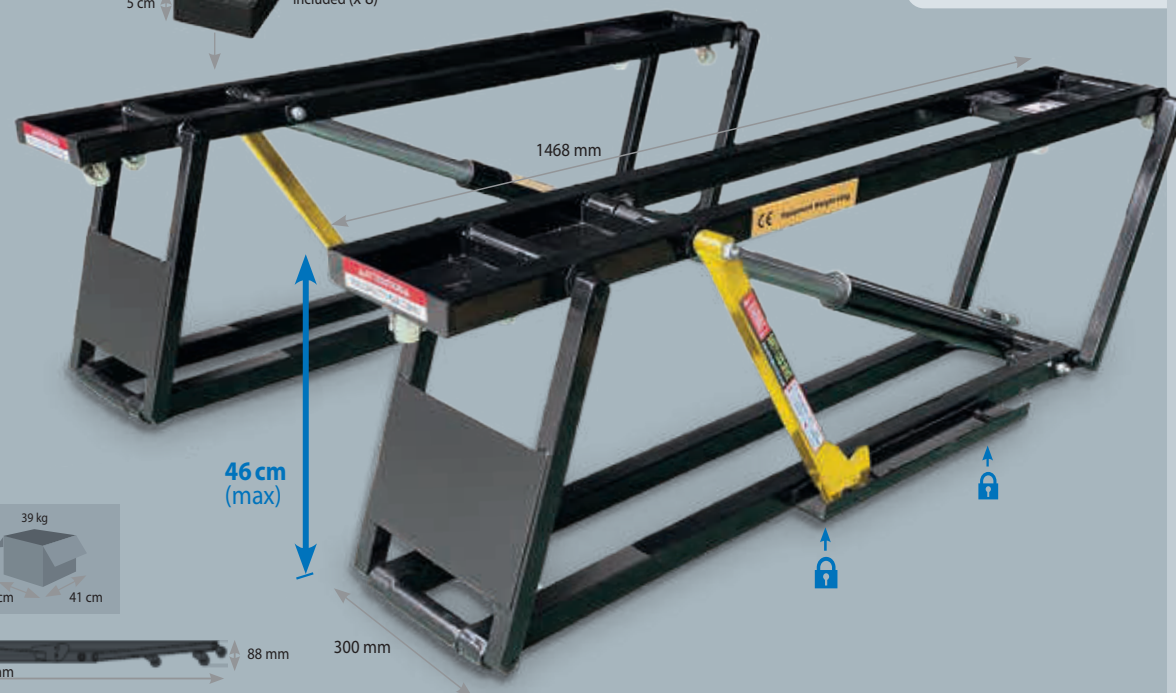

11 cm 43 kg
181 cm 37 cm
x 2 +
43 cm 39 kg
54 cm 41 cm

Made in China

OPTIONS

Extensions 1680 mm x 2
066328



x4 Patins à rainures
071933

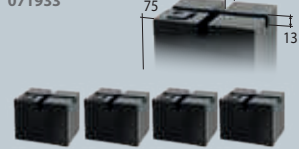

Pads for SUV x4 - Patins pour SUV x 4
065017



Wall mount -
Support mural
071926



AIR JACKS

DOUBLE BAG AIR JACK 082878

Pressure : 8 bar (116 PSI)
Weight 12 kg

60 x 52 x 14.5 cm
14.8 kg

SAFE
EN 1494

12 kg
LIGHT & COMPACT

TRIPLE BAG AIR JACK 082885

Pressure : 8 bar (116 PSI)
Weight 14 kg

62 x 56.5 x 18 cm
17.8 kg

SAFE
EN 1494

14 kg
LIGHT & COMPACT

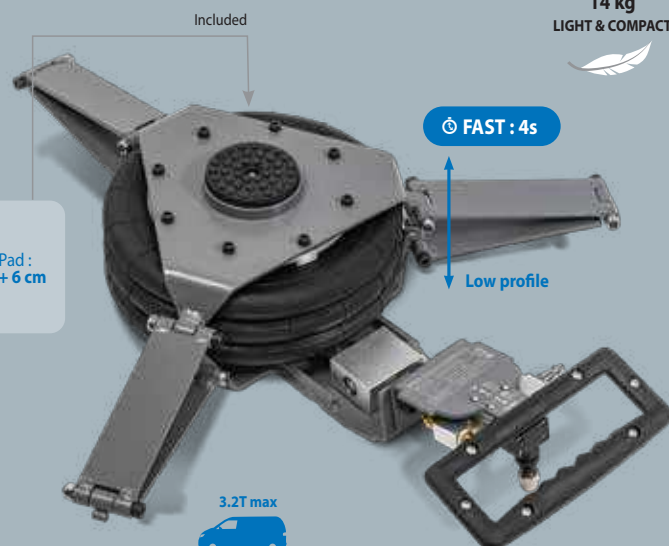
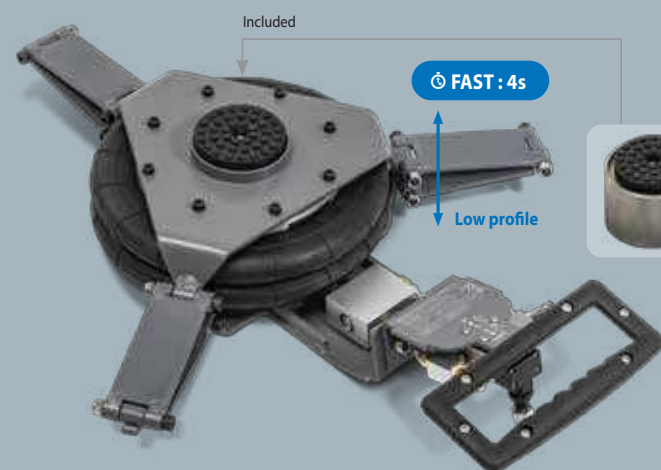

NEW
06/2024

NEW
06/2024

STABILITY ✓

STABILITY ✓

ERGO LIFT 1000 ROLL

Air 7-8 bars

SAFE
EN 1493

max 2.5 t

24 cm 437 kg
226 cm 115 cm

Ergo Lift
+ Wheels
+ Pump = 469 kg

High stability - Haute stabilité

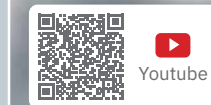
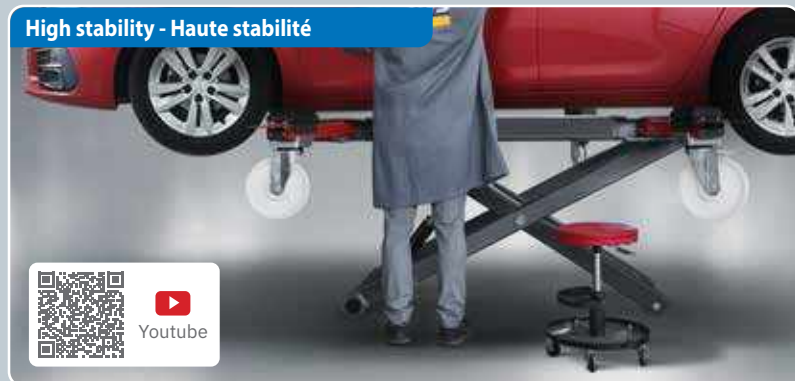

Handle for adjusting the
automatic locking support arms
- Poignée de positionnement
des bras porteurs avec
verrouillage automatique

SAFE
EN 1493

included:
(x4) 4 cm + (x4) 6 cm

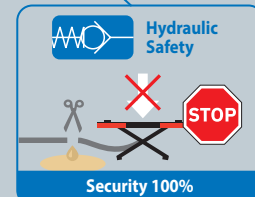
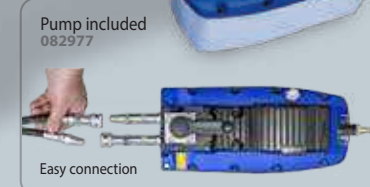
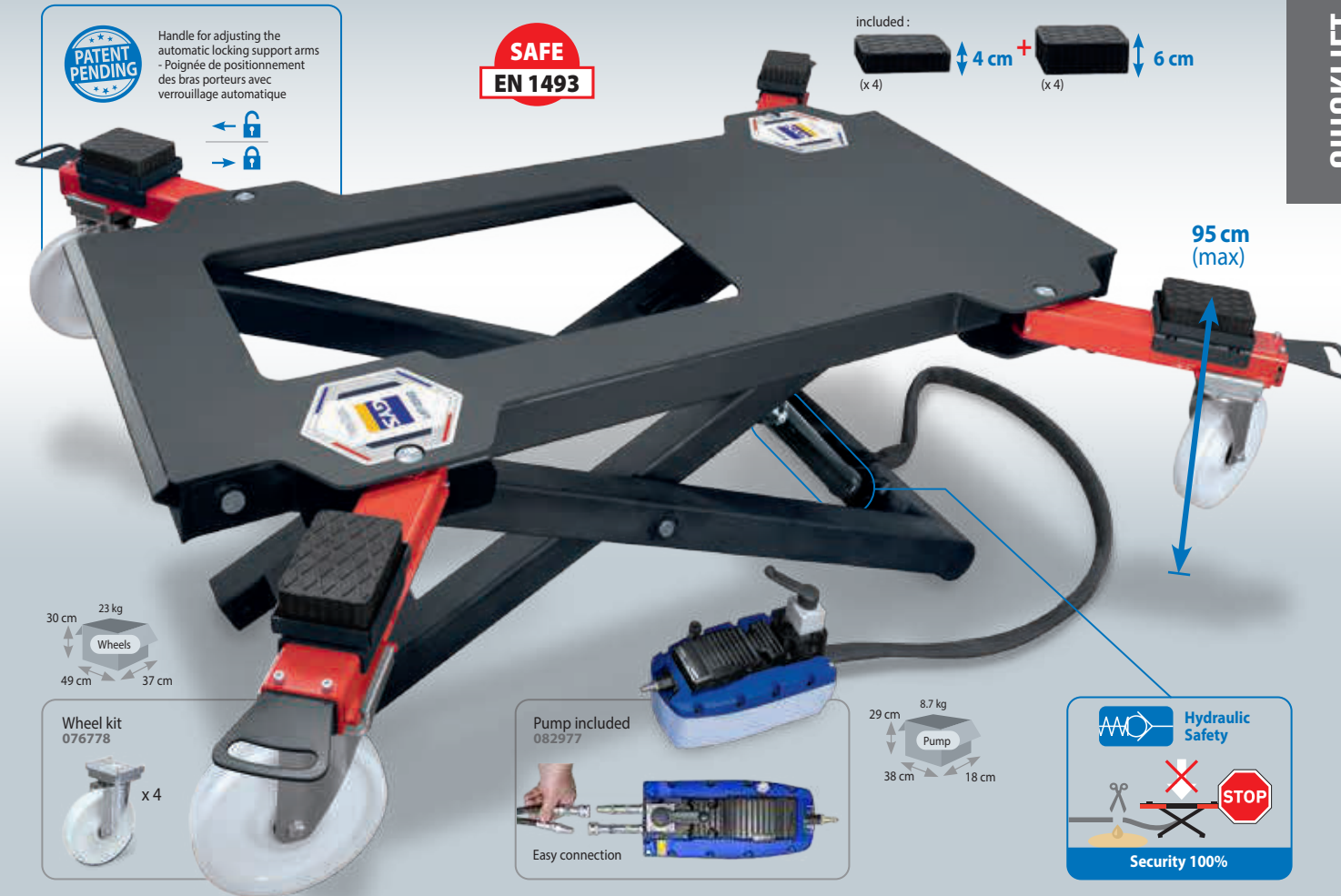

OPTIONS

Pads for SUV x4
- Patins pour SUV x 4
065017

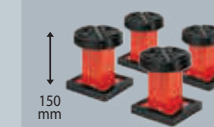

150 mm
32 cm 9 kg
90 cm 35 cm
Ramps

Ergo Lift ramps x2
- Rampes Ergo Lift x2
082717

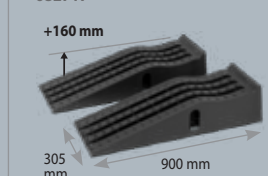

Capacity :
max 3.5 t
+160 mm
305 mm 900 mm
for Electric Vehicles
> 2 tons

Pack ERGO LIFT 1000 ROLL + wheels

076792



ERGO LIFT 1000 ROLL
067950

Pack ERGO LIFT 1000 ROLL + wheels + ramps

082984



ERGO LIFT 1000 ROLL
067950

Pump 082977
Wheel kit 076778
Ramps 082717

MANUAL DOOR LIFT

Ergonomic door handling trolley
 - Support Pro ergonomique de manutention de portière
 - Ergonomische Türhandhabungsunterstützung
 082670

Manufactured by GYS = SUPER PRO

117 x 28 x 27 cm
 40 kg

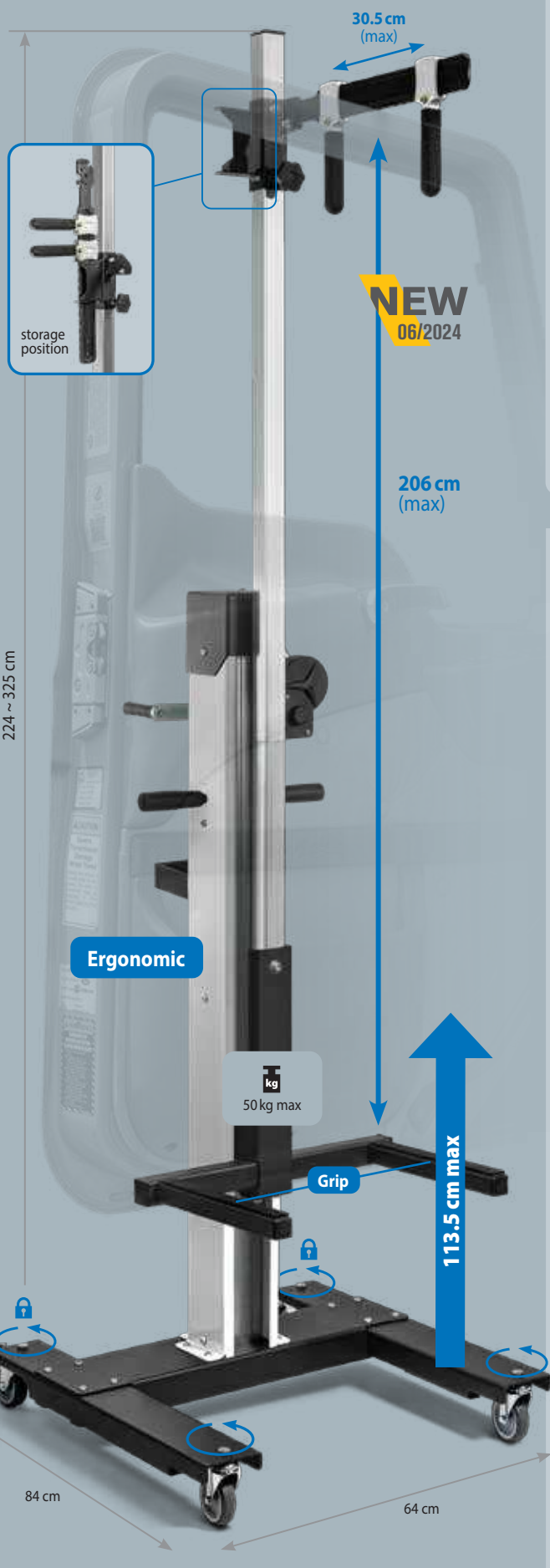

Option

Wide door accessory
 - Accessoire pour portière large
 - breites Türzubehör
 082700

NEW



MANUAL WHEEL LIFT

Wheel lift trolley
 - Lève roue à treuil
 - Radmontage-Heber
 061385

Manufactured by GYS = SUPER PRO

min: R13 / 135 / 65
 max: R22 / 300 / 35
 40 kg max

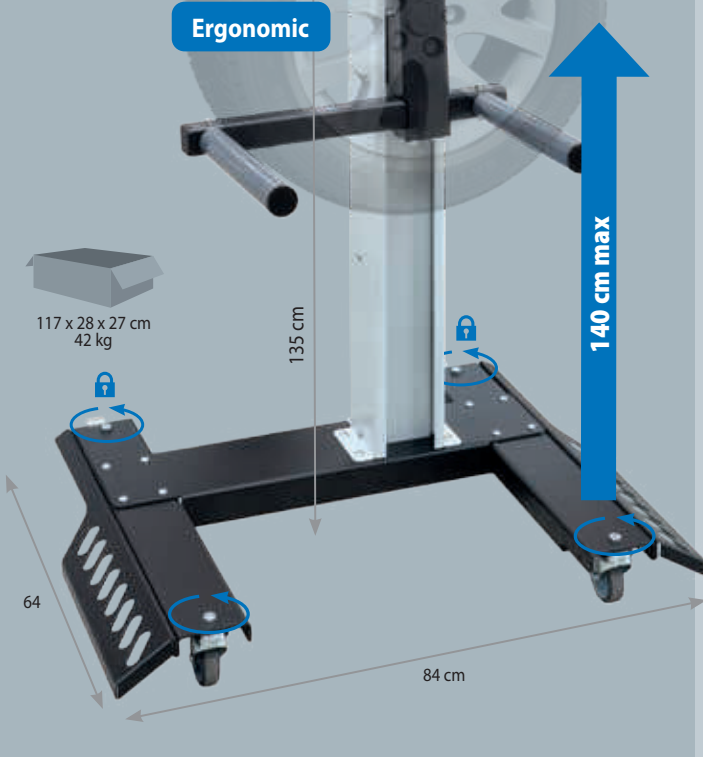

+

ACCESSORIES

WELDING HELMETS	122
FUME EXTRACTION	125
WINDSCREEN REPAIR	126
BUMPER REPAIR	128
HAND TOOLS	130
PNEUMATIC TOOLS	134
WORKING LIGHTS	136
SANDING & DUST EXTRACTION	138
WORKING SUPPORTS	140
ELECTRIC VEHICLES	144
SAFETY PROTECTION	146

HELMETS TECHNOLOGIES

Teinte initiale - Initial shade

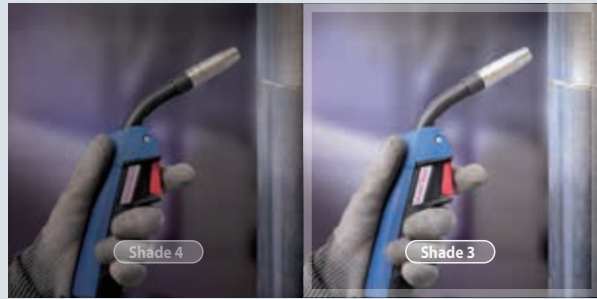

Classic

ULTRA CLEAR

Spectre de couleur - Spectrum view

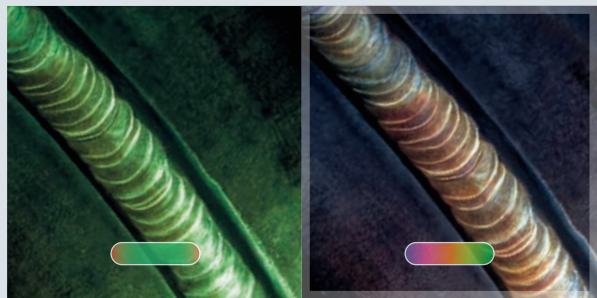

Classic

TRUECOLOR

Classification - X=/X=/X=/X=

1/1/1/1 = PERFECT QUALITY

(1) Optical quality (distortion). (2) Light diffusion (contrast). (3) Variation of light transmission (homogeneities of the dark shade). (4) Angular light (diagonal light ray filter).

(1) Qualité optique (distorsion). (2) Diffusion de la lumière (contraste). (3) Variation de la transmission lumineuse (homogénéités de la teinte foncée). (4) Lumière angulaire (filtre de rayons lumineux diagonaux).

Headgear - Serre-tête



Simple

Multi

Multi Pro

Multi Premium

Comfortable back

WELDING HELMETS

9-13

IDEAL



GYSMATIC 9-13 G
043909



◀ 100 x 60 mm | □→■ 0.08 ms

GRIND + (1/1/1) x 4 TRUECOLOR

WELDING HELMETS

5-9/9-13



Multi Premium



ALIEN XXL +
068698



◀ 100 x 93 mm

□→■ 0.08 ms

GRIND + (1/1/1) x 4 ULTRA CLEAR 3 TRUECOLOR

Body repair recommended



Multi Premium



GYSMATIC AUTO PRO
082809

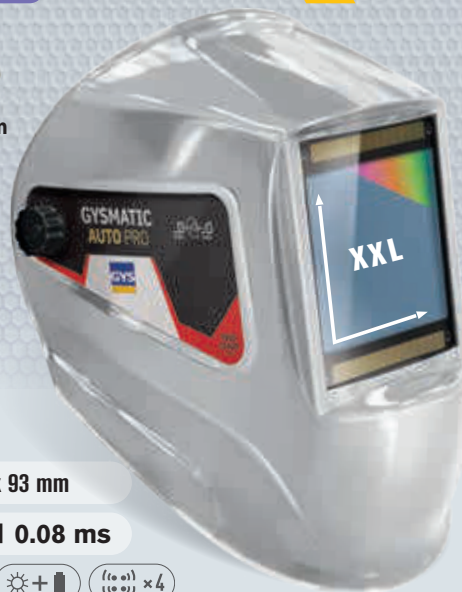

◀ 100 x 93 mm

□→■ 0.08 ms

GRIND + (1/1/1) x 4 CLASS 1/1/1/1 ULTRA CLEAR 3 TRUECOLOR

COMING SOON



GYSMATIC XXL & GYSMATIC 5/13 AIR XXL

DIGITAL MEMORY & REGULATIONS ELECTRONIC



Multi Pro



GYSMATIC 5-13 G XXL
037236



◀ 100 x 93 mm

□→■ 0.04 ms

GRIND + (1/1/1) x 5 ULTRA CLEAR 2 DIGITAL TRUECOLOR

PANORAMIC

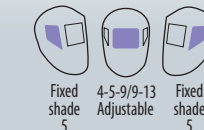

Fixed shade 5

Adjustable 4-5-9/9-13

Fixed shade 5



APOLLO + 3/5-13 G
068681



◀ 100 x 67 mm

□→■ 0.08 ms

GRIND + (1/1/1) x 4 PANORAMIC CLASS 1/1/1/1 ULTRA CLEAR 3 TRUECOLOR Multi Premium

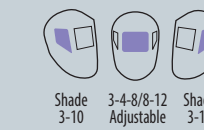

Shade 3-10

Adjustable 3-4-8/8-12

Shade 3-10



PANORAMIC 3XL
037281



◀ 114 x 85 mm

□→■ 0.04 ms

GRIND + (1/1/1) x 4 PANORAMIC ULTRA CLEAR 3 CLASS 1/1/1/1 ULTRA CLEAR 3 TRUECOLOR



Carry bag for helmet welding - Sac pour masque de soudage
043299



066656



Antiperspirant-headband - Bandeau anti-transpiration
043466 for Multi Premium, Multi Premium Pro, Multi, Simple
062627 for Multi Pro
070844 for Gysmatic 9/13 Air, Gysmatic 5/13 Air XXL



Magnifying glass - Loupe for Zeus, Ergotech & Alien True Color
x1
zoom x2 042780
zoom x3 064140

LENSES - Verres - Schutzgläser

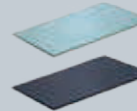

Code	Part No.	Dimensions	Part No.
114 x 133 (x10)	043893	G : 106 x 66 (x10)	043886
114 x 133 (x10)	043893	104 x 96 (x5)	043596
114 x 133 (x10)	043893	106 x 89,5 (x10)	046825
114 x 133 (x10)	043893	103.7 x 69.5 (x5)	077102
390 x 150 (x3)	037311	special kit (x1)	037304

Model	Shade	TRUECOLOR	□→■	HF	DELAY	CLASS	Sensitivity	Dimensions	Filter	Weight	Mask Brand
GYSMATIC 9-13 G	4-9>13	■	0.08 ms	✓	0.1 > 0.9s	1/1/1/2	4 HIGH SENSITIVITY	XL : 100x60 mm	■	580 g	Gys
GYSMATIC ALIEN XXL + GYSMATIC AUTO PRO	3-5>9/9>13	■	0.08 ms	✓	0.15 > 0.8 s	1/1/1/1	4 HIGH SENSITIVITY	XXL : 100x93 mm	■	540 g	Gys
GYSMATIC 5-13 G XXL	2-4>9/9>12	■	0.04 ms	✓	0.06 > 1.2 s	1/1/1/2	5 HIGH SENSITIVITY	XXL : 100x93 mm	■	550 g	Gys
APOLLO + 3/5-13 G	3-5>9/9>13 + 2x : 5	■	0.08 ms	—	0.15 > 0.8 s	1/1/1/1	4 HIGH SENSITIVITY	XL : 100x67 + 2x103.7x69.5 mm	■	585 g	Gys
PANORAMIC 3XL	3-4>8/8>12 + 2x : 3>10	■	0.04 ms	✓	0.15 > 0.8 s	1/1/1/1	4 HIGH SENSITIVITY	114x85 + 2x(68x80) mm	■	610 g	Gys

HELMETS VENTILATED

IDEAL



DIGITAL MEMORY & REGULATIONS ELECTRONIC



GYSMATIC 3/9-13 G AIR
0465727
069602

100 x 60 mm

0.08 ms



GYSMATIC 5-13 G AIR XXL
047846
028852

100 x 83 mm

0.1 ms



included with GYSMATIC 5/13 G AIR XXL

Filtration class EN 12941: TH2 P R SL
Air 165 / 200
220 L/min
Battery included

OPTION Filter TH3
065734



Battery charger
037472
028869



Battery included
037465



038424 x1



038417 x5

LENSES - Verres - Schutzgläser

			TRUE COLOR	HF	DELAY									L x W x H cm / g	MASK BRAND
114 x 133 (x10)	043893	G: 106 x 66 (x10)	043886												
GYSMATIC 3/9-13 G AIR		3-9>13	0.08 ms	✓	0.10>0.90 s	1/1/1/2	4 HIGH SENSITIVITY	XL: 100x60 mm	✓	☀ +2 (CR 2450)	Simple	28 x 25 x 28 / 1230	Gys		
114 x 133 (x10)	043893	106 x 89,5 (x10)	046825												
GYSMATIC 5-13 G AIR XXL		4-5>9 / 9>13	0.10 ms	✓	0.1 > 0.9 s	1/1/1/1	4 HIGH SENSITIVITY	XXL: 100x83 mm	✓	☀ +2 (CR 2450)	Multi Pro	27 x 25 x 28 / 1000	Gys		

FUME EXTRACTION SYSTEMS - Aspirateurs de fumée - Rauchgasabsauggerät

UNI 2.0 RE

- 400V 3~
- 50 Hz
- 1100 W
- 1500 m³/h max
- arm 3 m
- no plug
- 100 kg
- extraction 0.5 m/s

122 x 67 x 145 cm / 111.5 kg

061545



Ø 150 mm

Included
Pré filtre, treillis Aluminium
Class of filtration G3 EN 779
+ Filtre - Coal Filter EPA E12
EN 779, Filtration >99.5 %
046467

Options
Filtre à charbon actif -
Coal filter
☑ UNI 2.0 RE
064522

EVO 2.1 RE

- 230V 1~
- 50 Hz
- 1100 W
- 1200 m³/h max
- occasional
- arm 3 m
- included
- 85 kg

96 x 95 x 162 cm / 114 kg

061552



Ø 150 mm

Patented - Breveté

792 mm

347 mm

Included
Pré filtre, treillis Aluminium
Class of filtration F15 G2 EN 779
+ Filtre - Coal Filter HEPA H13
EN 779, Filtration >99.95%
046498

FUME EXTRACTION TORCHES - Torches aspirantes - Rauchgas-Absaugbrenner - Antorcha con aspiración de humos

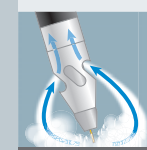

BINZEL

	Steel/Stainless steel - Acier/Inox - Stahl/Edelstahl			
	AIR		LIQUID	
	150 A	250 A	350 A	500 A
original equipment	M6	M6	M8	M8
Ø	Ø 0.8	Ø 1.0	Ø 1.2	Ø 1.2
X % 40°C - ArCO ₂	150A - 60%	200A - 60%	290A - 60%	380A-100%
GRIP	GRIP	GRIP	GRIP	GRIP
L	3m	3m	4m	4m
Ref.	043251	040540	040557	040564

For fume Extraction Torches - Pour torches aspirantes

BINZEL
073715



- 230V / 1 ~, 1100 W
- 230 m³/h max
- 190 mbar max
- 25 kg, 590 x 425 x 825 mm
- 76 db
- Filter auto cleaning system - Système de nettoyage automatique du filtre - Automatische Filterabreinigung

Filtre Classe M, EN 60335-2-69

included: 5 m, Ø50



• External evacuation Ø50 (hose not included)
• Évacuation extérieure Ø50 (tuyau non inclus)

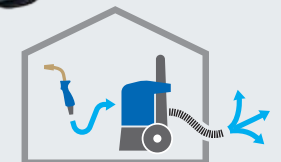

PROFESSIONAL BOX SET FOR WINDSCREEN REMOVAL - Coffret de découpe pare-brise
- Frontscheiben-Trennsystem für Akkuschrauberbetrieb

MADE IN
HIGH
QUALITY
GERMANY

057654

included
Axe enrouleur
068100

included
65 m
resistance 170 kg
Ø 0.79 mm
058125

optional
65 m
resistance 190 kg
Ø 0.92 mm
069275



OSCILLATING PNEUMATIC SAW FOR WINDSCREEN REMOVAL - Couteau pneumatique de découpe pare-brise
- Druckluft-Trennmesser für Windschutzscheiben

057623



Included
57 mm
057845

90 mm
057852



8 mm
057876

35 mm
057838

U
36 mm
057869

REMOVAL TOOL FOR WINDSCREEN WIPER ARMS - Extracteur d'essuie-glace - Wischerarm-Abzieher

UNIVERSEL
057630



EXPERT

Accès difficile
- Difficult access
057647



40 mm
max



WINDSHIELD CUTTING KIT - Système de découpe pare-brise à cliquet
- Set zum Lösen von Windschutzscheiben

054738

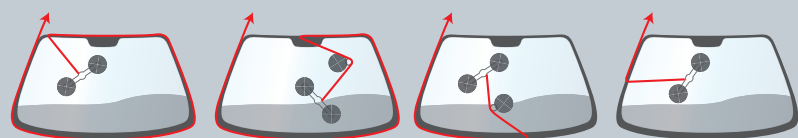

DASHBOARD PROTECTOR - Protections tableau de bord
- Armaturenbrett Schutz

053120

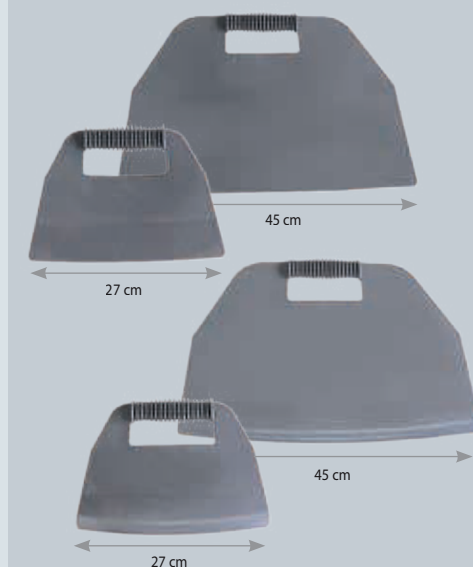

WINDSHIELD CUTTING TOOL - Outil découpe pare-brise
- Windschutzscheiben Demontage-Set

051935



WINDSCREEN JOINT-CUTTING KIT - Kit découpe joint de pare-brise - Scheibentrenn-Werkzeug-Set

051898



Corde à piano torsadé (22 m)
- Windscreen seal cutting wire
(twisted)
- Piano-Schneiddraht, gedreht,
22 m Rolle
051911



Corde à piano carré (50m)
- Windscreen seal cutting wire
(square)
- Vierkant-Draht,
50 m Rolle
051881

SUCTION LIFTING PADS - Ventouses - Saugnapfwerkzeug für Spiegelgläser

056695



051966



x6
057609



COMPRESSED AIR POLISHER - Renov'Polycarbonate - Druckluftpolierer

Complete pack

1 orbital sander
+ 1 polisher
- 1 ponceuse orbitale
+ 1 lustreuse

052086



2 SPEED

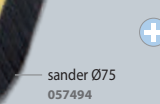
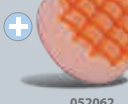
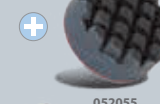

sander Ø75
057494

polisher Ø75
058224



Ø 76

P 500 (x 10)
P 800 (x 10)
P 1500 (x 10)
P 3000 (x 10)



P 500 x 50 052017
P 800 x 50 052024
P 1500 x 50 052031
P 3000 x 50 052048

HOT STAPLER FOR BUMPER REPAIR - Agrafeuse pour réparation pare-chocs - Stoßstangen Reparatur Kit

052925



INCLUDED:
x20 x20 x20 x20 x20

MADE IN TAIWAN

PORTABLE
Battery operated - Sur batterie
058118

included
Li-ion battery 3.7 V
048669
included adapters:
EUR, UK, USA & AUS

Charger included
048652

MADE IN TAIWAN



INCLUDED:
Ø 0.6, x100 Ø 0.8, x100

Ø 0.6, x100

Adjustable

Staples - Agrafes

Inside corner - Angle interne étroit Ø 0.7 mm	Crack alignment - Alignement de fissure Ø 0.7 mm	Large crack - Fissure importante Ø 0.7 mm	Internal angle - Angle interne Ø 0.7 mm	External angle - Angle externe Ø 0.7 mm
x 100 047990	x 100 047983	x 100 047976	x 100 047969	x 100 047952
052413				
= x 50	+ x 50	+ x 50	+ x 50	+ x 50

PIERCING KIT FOR BUMPER SENSORS - Coffret de perçage pare-chocs pour détecteurs - Lochwerkzeug für Stoßfänger



PRO +
059139

Ø 17-18-18,2
19-20-22,5-24
26-26,7-32 mm



FREEZER

Freezer spray
- Spray refroidisseur

-50 °C

400 ml

(x 12)
048898



TOOL FOR REMOVING BUMPER - Outil de déclipsage pare-chocs



076518



x15
076525

HAND SEAMER FOR PLASTIC REPAIR
Pince de serrage pour réparation des plastiques

082014



PLASTIC WELDING STATION - Station de soudage des plastiques - Kunststoff-Schweißset



320 W - 230 V, 1-50 Hz
Temperature: 160 < 480°C
▲ 3.4 kg
Length of hose: 1 m
Air flow: 24 l/min

Station seule
- Station only
064072



Ø 5 mm
066694

Ø 8 mm
066700

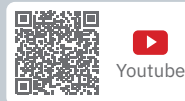

plastic rods - baguettes plastique 440 mm	PP / EPDM	▲ 4 mm	x 10	066304
		■ 6 mm	x 10	067622
ABS		▲ 4 mm	x 10	071322
		■ 8 mm	x 10	071339

Station	PP/EPDM			Pressure wheels	Mini milling machine	Scraper
	4mm (x10)	6mm (x10)	8mm (x10)			
064072	✓					
070974			✓			

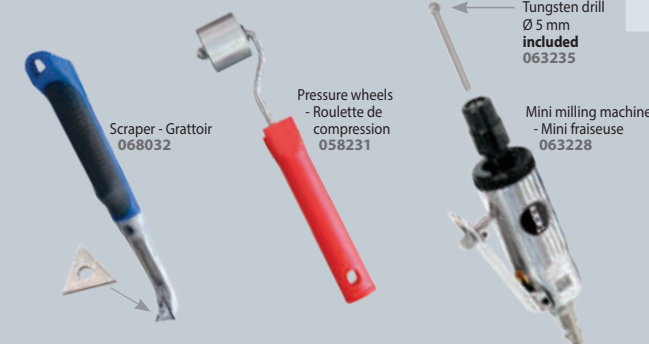

Scraper - Grattoir
068032

Pressure wheels
- Roulette de
compression
058231

Tungsten drill
Ø 5 mm
included
063235

Mini milling machine
- Mini fraiseuse
063228

WELDING KIT FOR PLASTICS - Kit de soudage des plastiques - Kunststoff-Schweißset



1 600 W - 230V - 50/60 Hz
max. 230 l/min
▲ 1.3 kg / -L- Ø100 x 300mm,
poignée Ø 56mm.

057678



3m

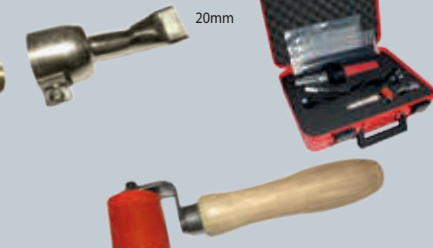

20mm

x10
052956

x1
25 x 12.5 cm
052949



Options



TIP Ø5
061262

TIP insert Ø5
061279

WORKSTATION PREMIUM 5 DRAWERS - Servante premium 5 tiroirs

± 64 kg
Capacity 320 kg



4 Keys - 4 Clés

Complete carbody workstation
080119

Workstation only
076143

included



HAND CHISEL FOR CAR BODY

- Burins
- Meißel für Karosserie

057586

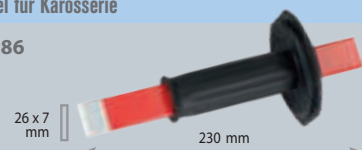

057593



SET OF 4 NYLON CHISELS - Jeu de 4 burins en nylon - 4 Kunststoffmeißel

054745

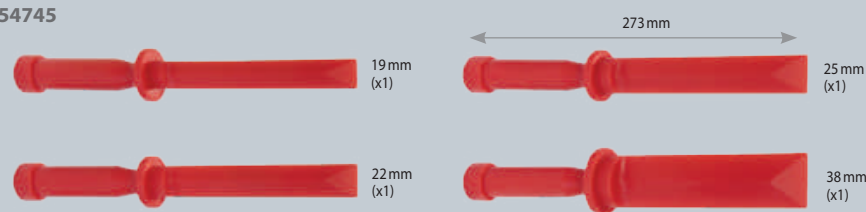

SET OF 3 CHISELS - Lot de 3 burins de séparation éléments collés - 3 Meißel

076754

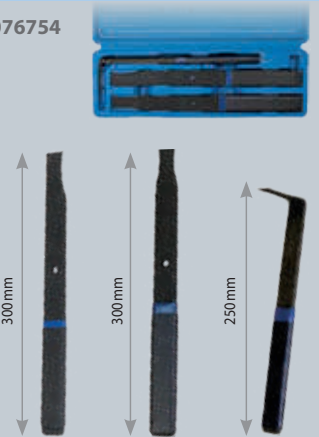

SET OF 3 SCRAPING KNIVES

- Couteaux racloirs

061439

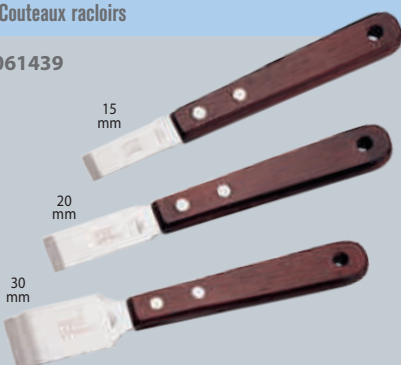

SET OF 30 TOOLS FOR SCRAPING/SANDING AND PAINT REMOVAL - Outils de dégarnissage et raclage - Polster & Schaber Kit

057616



HAND TOOLS - Ausbeulwerkzeug

• FULL PACK =
061637



+ • MEDIUM PACK
051133



PLANISHING HAMMER BLACKTEC®

077270

Rubberised gripping
- Manche en caoutchouc



MADE IN GERMANY

Corrosion resistant

ALU HAMMERS - Marteaux alu

020986



PLANISHING KIT FOR CAR BODY (SET OF 3 HAMMERS + 4 DOLLYS) - Kit marteaux et tas - Karosseriehammer & Handfaust Kit



SET OF 3 ALU HAMMERS + 4 ALU DOLLIES - Kit marteaux alu et tas - Karosseriehammer & Handfaust Kit



FORMING TOOLS - Outils de forme - Formgebungswerzeuge

051195



BODYWORK BUMPING Mallet - Maillet souple caoutchouc - Karosserie-Schlaghammer

083479



CONTOUR GAUGES - Jauges de profil - Konturenlehre



LIP PLIER - Pince à lèvres - Falzzange gebogen

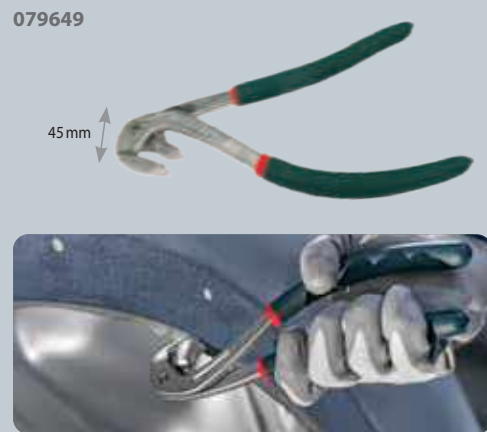

SET OF PLIER + 10 STAPLES - Coffret pinces à agrafes



POSITIONING CLAMP - Pincettes de maintien bord à bord - I-Stoß-Lehre



TEMPORARY-FASTENERS MANUAL MOUNTING - Serre-tôles



DOOR HINGE STRAIGHTENER - Redresseur de charnière de porte - Türgelekausrichter

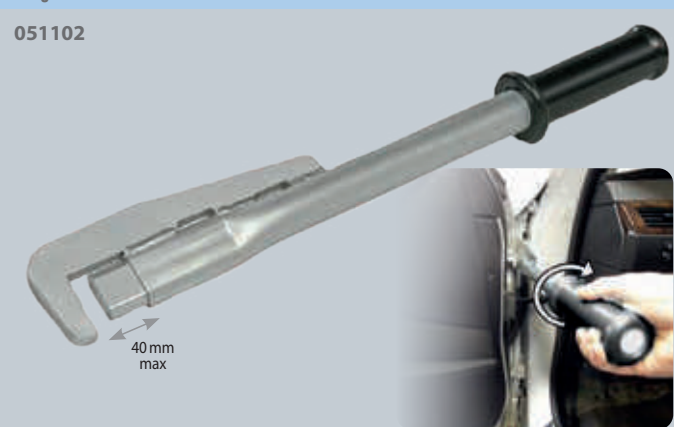

DOOR ALIGNING TOOL - Outil d'alignement de portière - Türausrichtungswerkzeug



GAPPING GAUGES - Jauges de positionnement - Spaltmaßlehre



FENDER ROLLER TOOL SET - Outil de remise en forme passage de roue - Kotflügelrollen-Werkzeugsatz

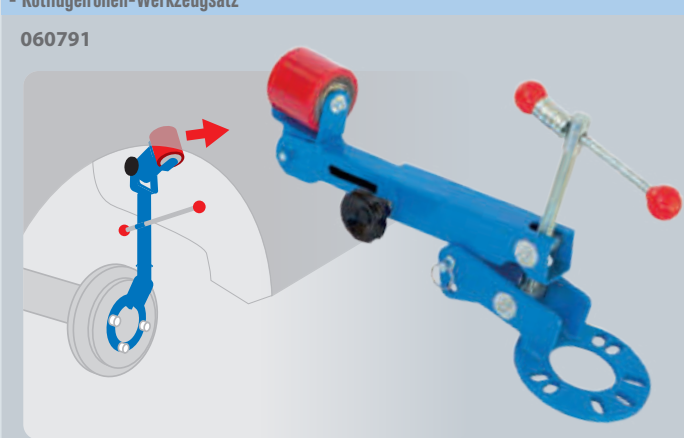

MICRO-GRIP CLAMPS - Pincettes micro-grip

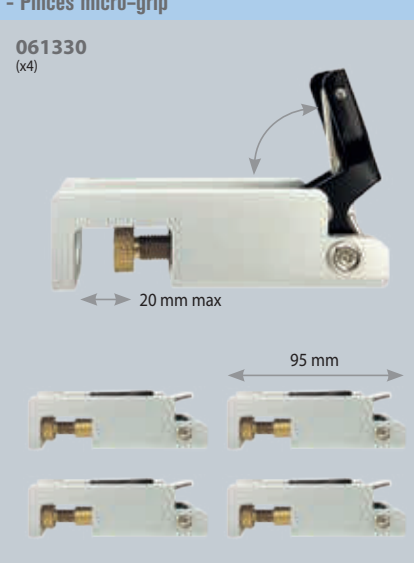

MICRO-WELDING CLAMPS - Micro-brides de soudage



FLAT NOSE LOCK-GRIP PLIERS - Pincettes étai à bec plat

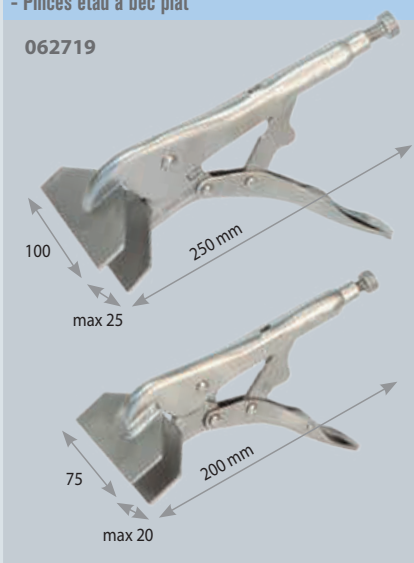

MULTI-CLIP PLIER - Pince multi-clip



BURR REMOVER - Outil d'ébavurage - Gratentferner

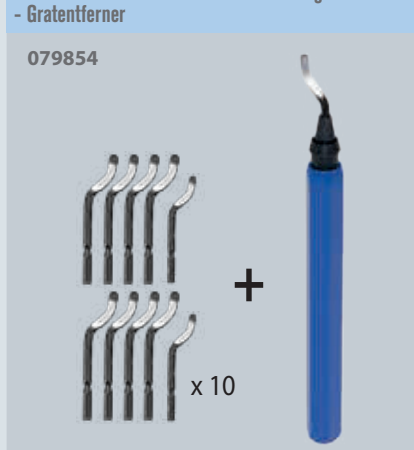

BODY LINE TOOL - Traceur de ligne carrosserie - Markierhilfe für Kanten



AXIAL-GRIP PLIERS - Pincettes axiales

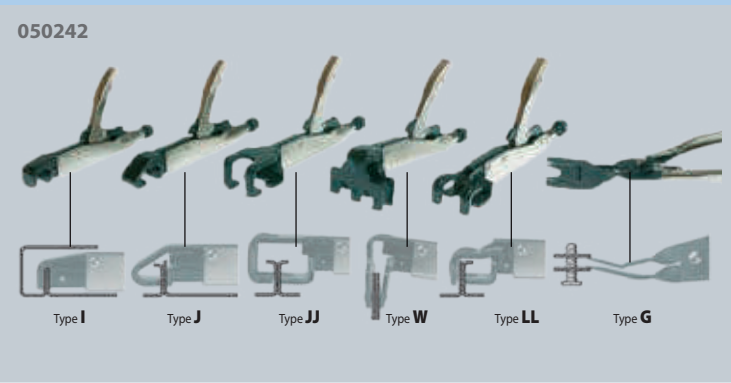

LOCK-GRIP PLIERS - Pincettes étai mono serrage

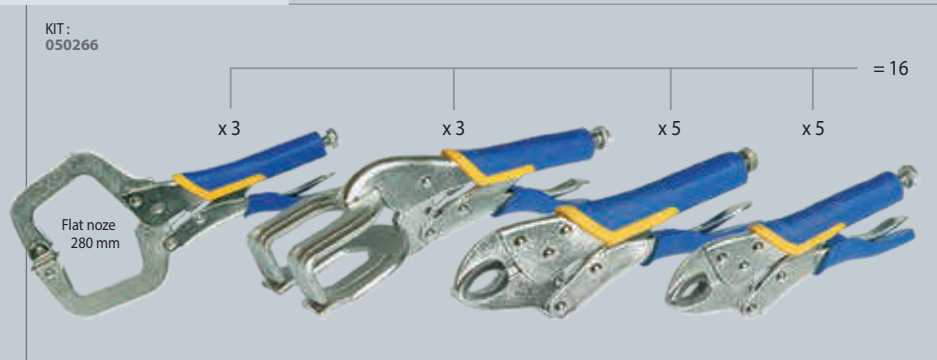
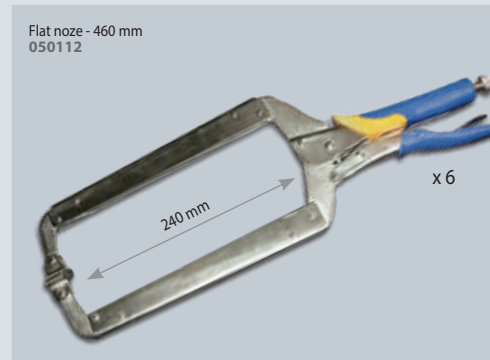
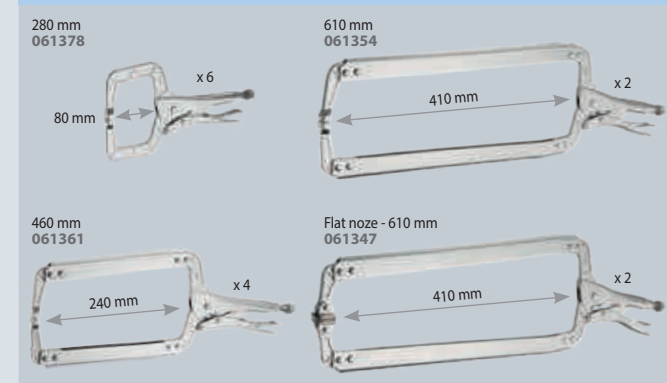

MINI DISC SANDER - Mini-meuleuse - Druckluftschleifer

051829

Speed adjustment

Ø 75 mm

Speed rpm	Power W	dB	Air consumption l/min	Air pressure bar	cm	kg
18000	200	83	171	6.2	12	0.7

Included (x1) 052468

LONG HANDLED ANGLE GRINDER - Meuleuse d'angle - Druckluft-Winkelschleifer

057753

Ø 100 mm

± 1.6 mm, x5 057883
± 0.8 mm, x5 058217

Speed rpm	Power W	dB	Air consumption l/min	Air pressure bar	cm	kg
14000	84	113	6.2	37	1.7	

058248

x2 Ø
Ø 50 & 75 mm

Speed rpm	Power W	dB	Air consumption l/min	Air pressure bar	cm	kg
15000	84	91	6.2	10	0.6	

MINI ANGLE GRINDER - Mini-meuleuse à renvoi d'angle - Mini-Druckluftwinkelschleifer geräuschgedämpft

051867

Ø 50 mm

90°

Speed rpm	Power W	dB	Air consumption l/min	Air pressure bar	cm	kg
15000	200	86	85	6.2	18	0.75

(x1) 052772

MINI-FLEXIDISC LAMELLES ZIRCON Ø 50 mm

K 40 (x10) 058255
K 60 (x10) 058262
K 80 (x10) 058279

AIR BELT SANDER - Ponceuse à bande à tête orientable - Druckluft Bandschleifer

060906

520 mm

360°

20 mm

Grain 60 (x 5) 060913
Grain 80 (x 5) 060920
Grain 100 (x 5) 060937
Grain 36 céramique (x 5) 062535

Speed rpm	Air consumption l/min	Air pressure bar	cm	kg
16 000	171	6.3	34	1.2

SAW FOR STRAIGHT CUT AND FILE - Scie coupe tôle droite et lime - Druckluftsäge und Feile

051805

(x5) 052789

included 058750

Speed rpm	Power W	dB	Air consumption l/min	Air pressure bar	cm	kg
5000	—	85	255	6.2	10	0.8

AIR BELT SANDER - Ponceuse à bande à tête orientable - Druckluft Bandschleifer

052819

360°

330 mm

10 mm

Grain 80 (x 10) 052833
Grain 36 céramique (x 20) 062528

Speed rpm	Air consumption l/min	Air pressure bar	cm	kg
16000	171	6.3	26	0.9

MINI ANGLE MILLING MACHINE - Mini-fraiseuse à renvoi d'angle - Mini-Winkelschleifer

051836

90°

Speed rpm	Power W	dB	Air consumption l/min	Air pressure bar	cm	kg
18000	500	81	85	6.2	18	0.7

AUTOMATIC MANDREL DRILL - Perceuse mandrin automatique - Druckluftbohrmaschine m. Schnellspannfutter

051799

Ø 13

Speed rpm	Power W	dB	Air consumption l/min	Air pressure bar	cm	kg
800	300	92	170	6.2	18	0.9

PNEUMATIC SURFACE REMOVER KIT - Coffret décapeuse pneumatique - Druckluftentroster-Box inkl. Zubehör

051775

Roue gomme 115 x 14 mm 051874
Roue à découper 115 x 14 mm 051843
Adaptateur pour brosse 051768

Brosse souple Brins droits 0.5 mm 103 x 23 mm 052598
Brosse dure Brins incurvés 0.7 mm 103 x 23 mm 051812
Brosse souple Brins incurvés 0.5 mm 103 x 23 mm 051850

Speed rpm	Power W	dB	Air consumption l/min	Air pressure bar	cm	kg
4000	500	86	102	6.2	280	1.2

PNEUMATIC FLANGE / PUNCHING TOOL - Pince à soyer et à trouser, pneumatique - Pneumatische Loch- und Absattzange

079892 Ø 8 mm
0.8 > 1,2 mm

052543 Ø 5 mm
0.8 > 1,2 mm

2 in 1

0.8 > 1,2 mm

MINI MILLING MACHINE - Mini Fraiseuse - Mini-Schleifer

063228

Option
Tungsten drill Ø 6 mm 054172

PUNCHING TOOL FOR OVAL HOLES - Outil de poinçonnage oblongs - Langlochkarosserieblechzange

2.2 kg

6 mm 20 mm 052437
8 mm 20 mm 067264

BODY ZIPPER - Sertisseuse pneumatique - Pneumatic Crimper - Druckluftkantenformer

056930

MADE IN HIGH QUALITY POLAND

1) MINI
2) initial W
3) final M x < 2.4mm
4) final D x > 2.4mm

Air pressure bar	cm	kg
5	28	2.1

LASER CORD METAL SHEET CUTTER (NIBBLER) - Dépointeuse pour cordon laser ACIER - Trennwerkzeug für Lasernähte

054165

Ø 6 mm

STEEL Included 054172

SPOT REMOVER - Dépointeuse - Druckluft-Schweißpunktbohrer

SPOT DRILL 050464

360°

Ø 8

Included: Tungsten Carbide Ø 8 for BORON/UHSS (x1)

HIGH QUALITY

Spot remover drill - Forets de dépointage - Schweißpunktfräse Tungsten Carbide for BORON/UHSS

Speed rpm	Power W	dB	Air consumption l/min	Air pressure bar	cm	kg
800	400	85	140	6.5	35	2.3

3-edge Ø 8 mm 053069 Ø 9 mm 069763 Ø 10 mm 053076
4-edge Efficiency ++ Durability ++ Ø 8 mm 059849 Ø 9 mm 069770

QR code
Youtube

PACK SPOT DRILL + 140 mm 061460

140 mm 061453

HAND LAMPS - Lampes baladeuses - Handleuchte

PORTABLE HAND LAMP 400 L 400 lumens

COB LED
Li-ion
Charging time: 8h
operating time
High position: 2.5 h
Low position: 5 h
Top light (1 W): 6 h

↳ 7 x 4 x 23 cm / 0.3 kg
⊗ 14 x 7 x 24 cm / 0.5 kg

059153



PRO PORTABLE LAMP 600 L 250-600 lumens

COB LED, 80 CRI
3.7 V - 2200 mAh Li-ion
micro USB charging (3.5 h)
operating time:
High position: 1.5 h,
Mid position: 4.5 h,
Top light (100 lumens): 10 h

IP 54
↳ 3 x 6 x 19 cm / 0.3 kg
⊗ 9 x 13 x 24 cm / 0.6 kg

060883



INSPECTION LAMPS - Lampes d'inspection - Inspektionlampen

INSPECTION HEADTORCH 280 L 100-280 lumens

3 W COB LED, 80 CRI+, 6500 K
3.7 V - 1500 mAh Li-po
micro USB charging
mains charger not incl.
operating time
High position: 2 h
Low position: 6 h
IP 65
↳ 8 x 5 x 4 cm / 0.1 kg
⊗ 5 x 11 x 18 cm / 0.2 kg

060845



360° PORTABLE WORKSPACE LAMP 1000 L 60-1000 lumens

>80 CRI SMD LED
6500 K
3.7 V - 5200 mAh Li-ion
USB charging (4.5h)
USB power supply
operating time 2 > 27 h

IP 54
↳ 26 x 7 x 7 cm / 0.5 kg
⊗ 8 x 8 x 35 cm / 0.7 kg

059764



MINI INSPECTION LAMP 200 L 120-200 lumens

COB LED, 80 CRI, 6500 K
3.7 V - 700 mAh Li-ion
micro USB charging (2.5 h)
mains charger not included
operating time
High position: 1.5 h
Low position: 4 h
Top light: 3.5 h
IP 20
↳ 18 x 3 x 3 cm / 0.1 kg
⊗ 18 x 5 x 3 cm / 0.2 kg

060852



MINI INSPECTION LAMP 350 L 0-350 lumens

COB LED
3.7 V - 1100 mAh Li-ion
USB charging (3 h)

operating time
3 > 6.5 h

IP 20

075894

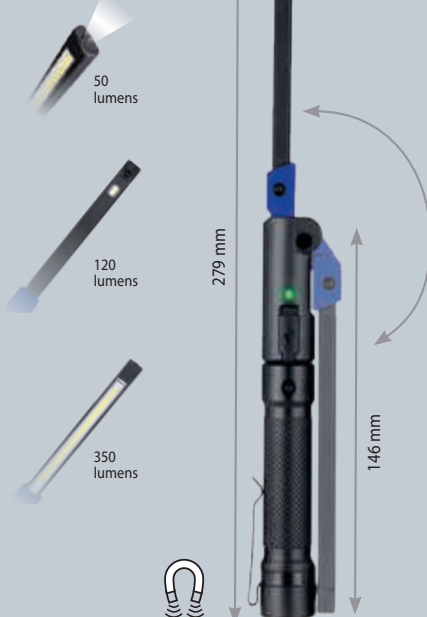

PRO INSPECTION LAMP 800 L 120-800 lumens

COB LED
3.7 V - 2600 mAh Li-ion
USB charging (4 h)

operating time
2.5 > 9 h

IP 54

075900

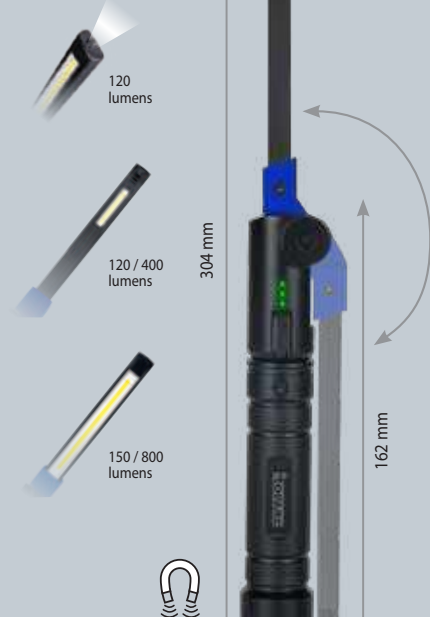

LED WORKLIGHTS WITH TRIPOD - Projecteurs led sur trépied - LED-Arbeitsleuchte mit Standfuß

TRIPOD LAMP 1800 L 1800 lumens

3x 55 COB LED
total 165 LED

1.8 m power cord

059146

⊗ 95 x 15 x 14 cm / 3.2 kg

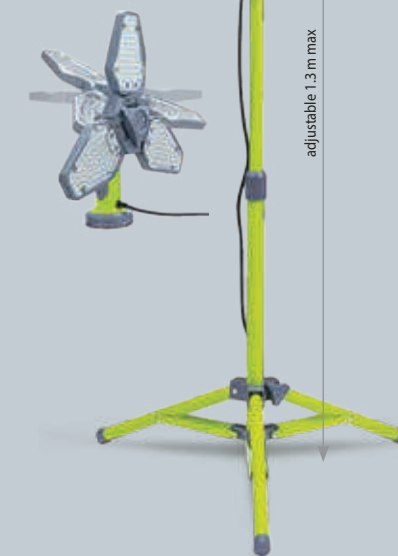

TRIPOD LAMP 3000 L 3000 lumens

35 W COB LED

2 m power cord

IP 44

059979

↳ 100 x 20 x 9 cm / 3.6 kg
⊗ 103 x 22 x 10 cm / 4.1 kg



TRIPOD LAMP 4000 L 4000 lumens

3x 20 COB LED,
total 60 LED

3 m power cord

059986

↳ 21 x 15 x 114 cm / 5.7 kg
⊗ 22 x 116 x 117 cm / 6.4 kg



UNDER BONNET LAMPS - Lampes sous capot - Leuchte für Motorhaube

UNDER BONNET HAND LAMP 600 L 500-1000 lumens

120 COB LED

3.7 V - 4000 mAh Li-ion
charging time: 10/12 h

operating time
High position: 4 h
Low position: 8 h

↳ 22 x 11 x 68 cm / 1.8 kg
⊗ 24 x 12 x 70 cm / 2.3 kg

059962

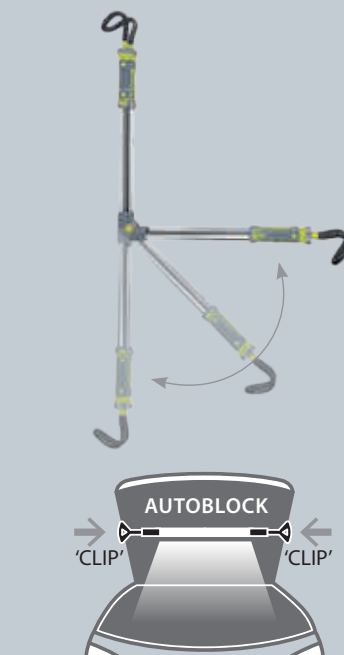

UNDER BONNET LAMP AND TRIPOD 800 L 250-800 lumens

120 COB LED

3.7 V - 4000 mAh Li-ion
charging time: 10/12 h

operating time
High position: 3 h
Low position: 6 h

↳ 60 x 10 x 7 cm / 1.2 kg
⊗ 61 x 15 x 12 cm / 2 kg

058002

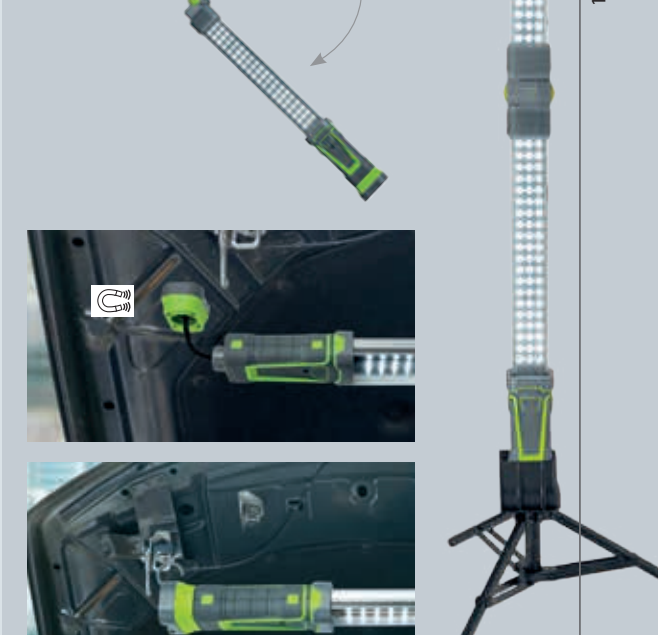

DETAILING & COLOUR MATCH - Contrôle des couleurs - Fabnpassung & Aufbereitung

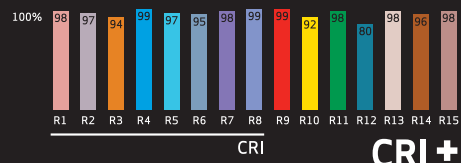

4500 K

400 lumens

SUNCOLOR 1
COB LED, CRI > 95, 1100 lux
3.7 V - 2600 mAh Li-ion
USB charging
operating time : 3 h
↓ 6 x 3 x 19 cm / 0.6 kg
⊗ 22 x 14 x 10 cm / 0.7 kg
IP 65

058477



3 COLORS

2700 - 4500 - 6500 K

350-420-450 lumens

SUNCOLOR 3
COB LED, 96 CRI+
3.7 V - 2600 mAh Li-ion
micro USB charging (4 h)
operating time : 2.5/4 h
IP 65
↓ 4 x 6 x 9 cm / 0.3 kg
⊗ 9 x 13 x 24 cm / 0.6 kg

060838



5 COLORS

2700 - 3500 - 4500 - 5500 - 6500 K

500-1000-2000 lumens

SUNCOLOR 5
COB LED, 96 CRI+
11.1 V - 4400 mAh Li-ion
charger 110/240 V, 5 m cable, 15 V, 1.5 A
operating time : 3.5 h
operating time
High position : 2 h, Mid : 4 h, Low : 8 h
IP 65
↓ 7 x 23 x 20 cm / 1.2 kg
⊗ 9 x 25 x 24 cm / 1.9 kg

060876

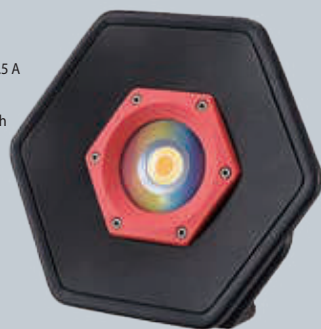

5 COLORS

2500-3500-4500-5500-6500 K

50-200-500 lumens

SUNMATCH 4
COB LED, 96 CRI+, 700-1400 lux
3.7 V - 2600 mAh Li-ion, USB charging
operating time :
High position : 2 h, Low position : 4 h
IP 65
↓ 4 x 6 x 19 cm / 0.3 kg
⊗ 8 x 9 x 21 cm / 0.5 kg

061651



UV CURING - SÉCHAGE UV

UV LED λ 395-400 nm

Irradiance 6-15 mW/cm²

NOVA-UV 5

3.7 V - 5400 mAh Li-ion
USB charger, 1 m cable, 5 V, 2 A
charging time : 3.5 h
curing area : Ø 20 cm
operating time 1.5 h
IP 67
↓ 7 x 17 x 16 cm / 0.9 kg
⊗ 7 x 17 x 18 cm / 1 kg

061620



FILM COATING THICKNESS GAUGE

- Détecteur épaisseur de peinture

059856

Measurement range : 0 - 1.80mm
Resolution : 0.01mm / 1mm
Measurement error : +/- 0.03 mm
Power Supply : 2x 1.5V AAA batteries (included)
Overall dimensions : 62 x 30.5 x 105 mm



4 MAGNETIC PANEL EDGE PROTECTIONS

- 4 protections magnétiques de ponçage pour bord de panneau

082793

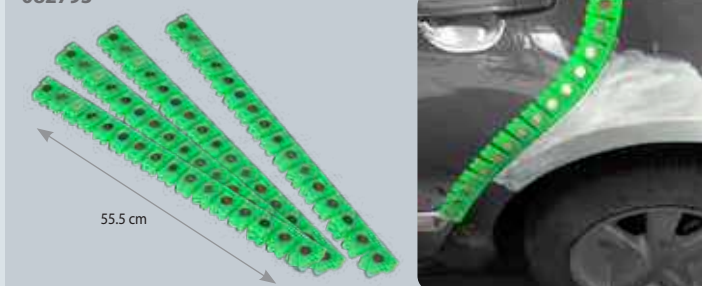

ELECTRIC SANDER & POLISHER

- Ponçeuse /polisseuse électrique - Elektro-Polier-Schleifer

057999

Orbital 5.0 mm
↓ 27 x 15 x 10 cm / 1.5 kg
⊗ 37 x 18 x 12 cm / 1.9 kg

Speed : 4000, 7000, 9000 10000 rpm
AC-in 220V - 230V / 50 - 60Hz

Light weight
& Compact

((No vibration))



058293

Power supply : 230V / 50Hz
Power : 1400W (max 2000W)
Max. vacuum : 170 mbar
Air flow : 2700 l/min
Drum capacity : 30 L
Drum material : stainless steel

↓ 33 x 33 x 63 cm / 4.9 kg
⊗ 38 x 38 x 67 cm / 7.8 kg

Manual
or
automatic



GYS DUST EXTRACTOR - Pneumatic dust vacuum cleaner for sander

INNOVATIVE SUCTION SYSTEM

Depression 1150 mm H2O

Air flow 600 l/min

Air consumption 340 l/min



Adjustable sander pressure - Pression ponçeuse ajustable
5 bar max

↓ 49 x 48 x 88 cm / 21.5 kg
⊗ 81 x 40 x 49 cm / 24.1 kg



ATEX norm
Group II - Category 3

EN 60335-2-69 : 2012

- ✓ **ROBUST**
- ✓ **QUICK & SAFE**
- ✓ **LOW AIR CONSUMPTION**
(5 bar)
- ✓ **NO ELECTRIC MOTOR**
- ✓ **ENERGY SAVING**

Sanding discs box*
- Rangement pour disques de ponçage*
* discs box not included - disques de ponçage non inclus

Grande maniabilité et stabilité
- High maneuverability and stability

EASY ACCESS

Maintenance free
- Aucune maintenance



Consumables

Sac à poussières - Filter bag
Capacity 5 kg
Included x1
x 5
058880



Pneumatic Sander
- Ponçeuse pneumatique
MIRKA PROS 650CV
Ø 150 mm
071346

2 MODELS

GYS DUST EXTRACTOR

MANUAL

Manual start
- Démarrage manuel

071353



GYS DUST SELF EXTRACTOR

AUTOMATIC

BREVET GYS
GYS PATENT
Automatic start
- Démarrage automatique

077058



ERGONOMIC PRO SUPPORT FOR PAINTING ELEMENTS - Support Pro ergonomique pour peinture d'éléments
- Ergonomische Pro-Unterstützung für Malelemente

082656

NEW
05/2024

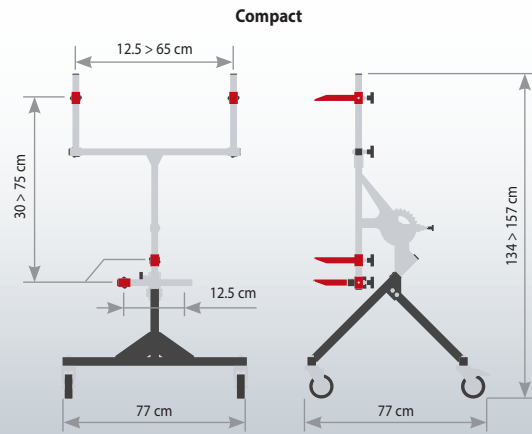
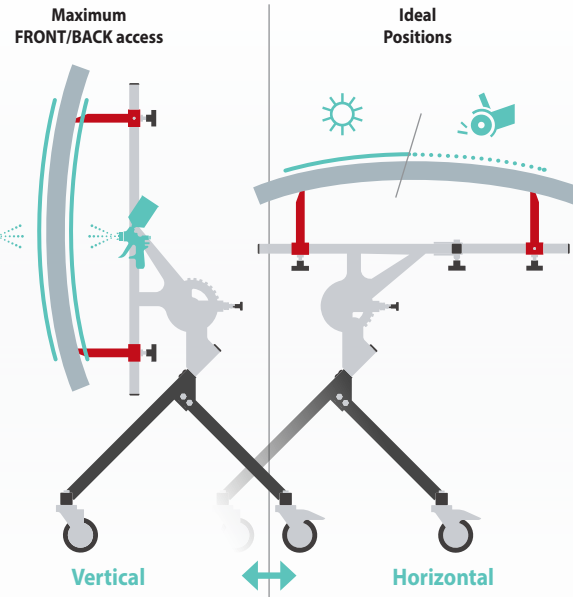
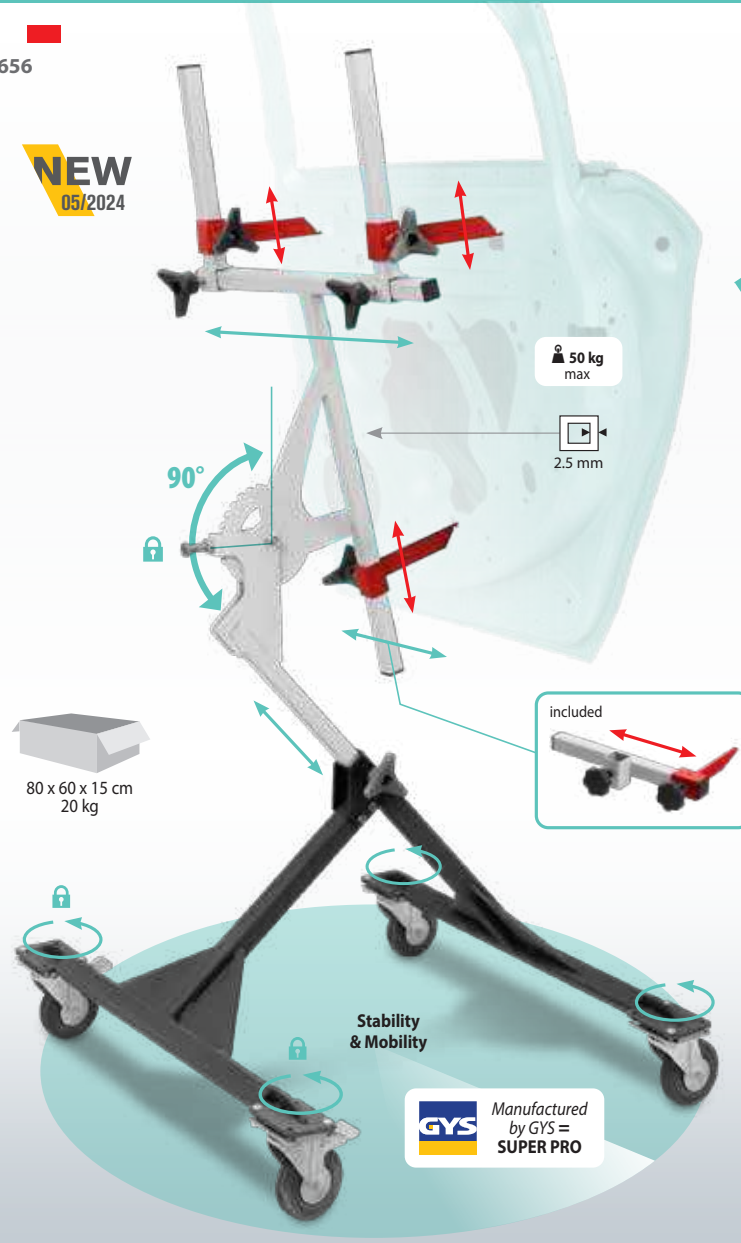

Stability & Mobility
GYS Manufactured by GYS = SUPER PRO

FRAMES SUPPORT - Tréteaux - Klappbücke

<p>Adjustable catenary - Chainette réglable</p> <p>Protecting foam - Mousse de protection</p> <p>Non-slip base - Antidérapants</p>	<p>040601 ↓ 105 x 33 x 9 cm / 6.3 kg ⊗ 107 x 35 x 10 cm / 6.7 kg</p> <p>Ø 28 mm</p>	<p>040250 ↓ 100 x 105 cm - 7.1 kg ⊗ 104 x 10 x 32 cm / 7.5 kg</p> <p>Ø 32 mm</p>	<p>083875 14.4 kg ⊗ 108 x 9 x 47 cm / 16.5 kg</p> <p>30 > 80 cm</p> <p>70 > 95 cm</p> <p>101 cm</p> <p>NEW</p>
<p>Suction pad for glazing - 4 ventouses Dépose vitrages - Gummiteiler zur Fixierung von Glasscheiben</p>	<p>040311 ↓ 106 x 31 x 6 cm / 6.6 kg ⊗ 106 x 31 x 11 cm / 9.7 kg</p> <p>Ø 32 mm</p>	<p>040304 ↓ 105 x 109 cm / 7.2 kg ⊗ 107 x 32 x 10 cm / 7.8 kg</p> <p>Ø 32 mm</p>	<p>Light and easy to handle Ideal for horizontal works - Léger et très maniable Spécial travaux à l'horizontal - Speziell geeignet für Arbeiten in horizontaler Position</p>

ROTARY ELEMENT SUPPORT - Support pare-chocs - Lackierstander für Stoßstange, einstellbar

052376
↓ 50 x 70 x 10 cm / 7.3 kg
⊗ 60 x 77 x 12 cm / 8.3 kg

Adapted to wing mirror covers - Adapté aux coques de rétroviseurs - Geeignet für Außenspiegel

TELESCOPIC FRAMES SUPPORT - Tréteaux télescopiques - Teleskopbücke

<p>070677 29 kg</p> <p>NEW 08/2024</p> <p>30 > 100 cm</p> <p>85 > 120 cm</p> <p>81 cm</p> <p>⊗ 81 x 74 x 14 cm / 30.7 kg</p>	<p>070677 16.5 kg</p> <p>MADE IN HIGH QUALITY POLAND</p> <p>15 > 125 cm</p> <p>88 > 128 cm</p> <p>20 x 20 mm</p> <p>3 mm</p> <p>87 cm</p>
---	---

ROTARY ELEMENT SUPPORT - Support élément rotatif - Lackierstander für Stoßstange, einstellbar

1.5 mm

360°

2 mm

052611
200 x 101 cm - 19 kg
⊗ 112 x 35 x 13 cm / 23 kg
Made in China

PRO 056725
200 x 105 x 81 cm - 21.5 kg
⊗ 120 x 26 x 18 cm / 22 kg

MADE IN HIGH QUALITY POLAND

WHEELS PAINTING SUPPORT - Support de peinture pour 2 jantes - Lackträger für 2 Felgen

082168
⊗ 83 x 45 x 35 cm / 25 kg

15" → 22"

109 cm

95 cm

67 cm

MASKING MACHINE - Chariot de marouflage - Abdeckpapier-Ständer

083905
132 x 95 x 91 cm / 35 kg
⊗ 109 x 92 x 27.5 cm / 37 kg

NEW

x 4 (not included)

Paper roll - Rouleaux de papier - Papierständer

30, 60, 100, 100 cm

Ø 75 mm

Ø 250 mm

PREMIUM MASKING MACHINE - Chariot de luxe marouflage - Abdeckpapier-Ständer

057333
150 x 133 x 62 cm / 31 kg
⊗ 152 x 30 x 18 cm / 31.5 kg

x 5 (not included)

Paper roll - Rouleaux de papier - Papierständer

30 > 120 cm

Ø 75 mm

Ø 250 mm

MASKING MACHINE - Chariot de marouflage - Abdeckpapier-Ständer

056954
150 x 62 x 110 cm / 11 kg
⊗ 154 x 30 x 19 cm / 12 kg

MADE IN HIGH QUALITY POLAND

x 3 (not included)

Paper roll - Rouleaux de papier - Papierständer

30, 60, 90 cm

Ø 75 mm

Ø 250 mm

OPTION
Ø 40 mm x 6
058897

STORAGE TROLLEY - Chariot de stockage
- Lagerrollwagen

059825

106 x 104 x 215 cm - 32.5 kg
112 x 31.5 x 21.5 cm
+ 12 x 9.5 x 194.5 cm

STORAGE TROLLEY - Chariot de stockage
- Lagerrollwagen

059832

↓ 50 x 150 cm / 11.3 kg
155 x 18 x 12 cm / 13.8 kg

STORAGE TROLLEY - Chariot de stockage
- Lagerrollwagen

040243

71 x 90 x 197 cm / 41 kg

⊗ 2 : 90 x 6 x 147 cm + 97 x 74 x 24 cm

ROUND STOOL WITH TOOL STORAGE
- Tabouret - Werkstatt-Rollhocker

057555

38 x 38 x 44 cm - 5.2 kg
⊗ 41 x 19 x 41 cm / 5.6 kg

max : 50 cm
min : 38 cm

6 cm

WORKSTATION PREMIUM 5 DRAWERS
- Servante premium 5 tiroirs

076143

⊗ 64 kg
Capacity 320 kg

4 Keys - 4 Clés

32 x 45 x 6 cm
65 x 48 x 12 cm
75 x 47 x 9 cm
65 x 45 x 12 cm
32 x 45 x 12 cm

105 cm

56 cm 87 cm

UNIVERSAL SUPPORT - Chariot pour éléments de carrosserie
- Universelle Ständer

083868

56 kg
⊗ 102 x 72 x 27 cm / 59 kg

NEW

210 cm

+ 60 cm

85 cm 100 cm

FOLDING STEP STOOL - Marche pied (Aluminium)
- Arbeitspodest klappbar

080041

7.3 kg
⊗ 100 x 39.5 x 19 cm / 8.1 kg

ALU

150 kg max

850 mm

490 mm

1180 mm

300 mm

MOBILE RACK FOR CAR BODY REPAIR - Rack mobile pour éléments de carrosserie

082472

⊗ 128 x 30 x 15 cm / 20 kg
↓ 18.8 kg

NEW

150 kg max

635 mm

1200 mm 700 mm

FOLDING STEP STOOL - Marche pied (Aluminium)
- Arbeitspodest klappbar

057562

7.9 kg
⊗ 102 x 39 x 19 cm / 8.5 kg

ALU

150 kg max

960 mm

475 mm

385 mm

FLAP LOCK - Tiges de blocage

056732

30 > 115 cm

FOLDING STEP STOOL - Marche pied (Aluminium)
- Arbeitspodest klappbar

058552

↓ 113 x 41 x 16 cm / 16 kg
⊗ 117 x 42 x 17 cm / 17 kg

ALU

150 kg max

1090 > 1750 mm

520 > 900 mm

300 mm

ROUND STOOL WITH STORAGE
- Tabouret d'atelier 3 tiroirs

079878

47 x 35 x 43 cm
⊗ 38.5 x 37 x 38.5 cm - 13 kg

MECHANICS CREEPER WITH TILTING HEADREST
- Chariot de visite - Werkstatt-Rollliege

057548

102 x 43 x 11 cm / 5.3 kg
⊗ 104 x 45 x 13 cm / 6 kg

MOBILE WORKSTATION
- Table de travail mobile

079465

⊗ 120 x 82 x 18 cm / 40.3 kg

100 kg max

1170 mm

390 mm

1030 mm

750 mm

Ø 290 mm

2 IN 1 MECHANICS CREEPER
- Chariot de visite 2 en 1 - Werkstatt-Rollliege

079861

102 x 40 x 14 cm
⊗ 40 x 13 x 63 cm - 7.6 kg

WORKSTATION 3 SHELVES
- Servante 3 plateaux

068056

⊗ 77 x 53 x 21 cm / 18.2 kg

65 kg max

65 kg max

65 kg max

835 mm

300 mm 800 mm

1T MOBILE LIFTING TABLE WITH HYDROPNEUMATIC PUMP - Table élévatrice mobile 1 tonne avec pompe hydropneumatique
- Mobilier 1-Tonnen-Hubtisch mit hydropneumatischer Pumpe

083912
Weight : 385 kg



Reserved holes pattern
- Quadrillage de trous taraudés
100 x 100 mm
M10

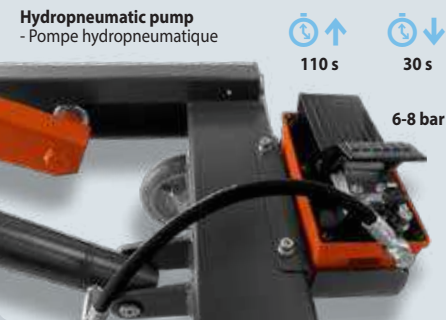
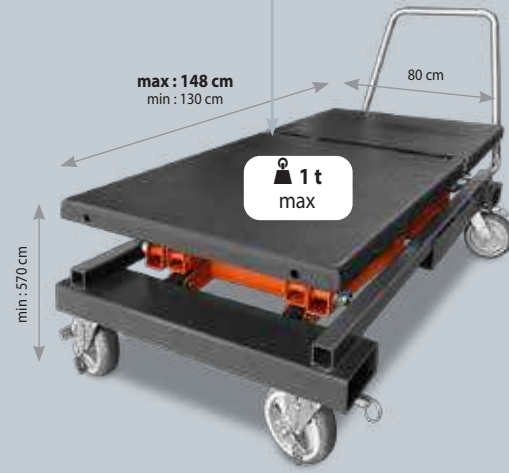

1.2T LIFTING TABLE FOR ELECTRIC VEHICLE BATTERIES - Table de levage 1.2T pour batteries de véhicule électrique
- 1,2T Hubtisch für Elektrofahrzeugbatterien

083929
Weight : 760 kg

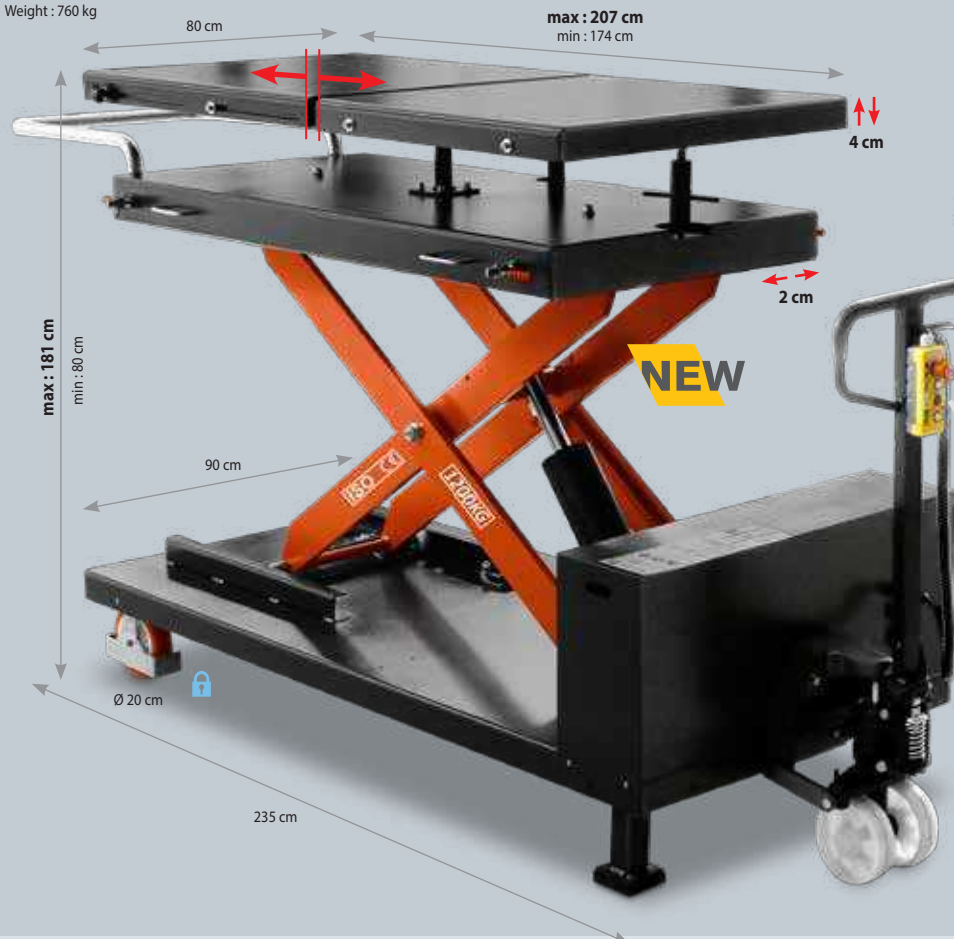

Reserved holes pattern
- Quadrillage de trous taraudés
100 x 100 mm
M10



EQUIPMENT FOR OPERATIONS ON ELECTRIC AND HYBRID VEHICLES - Équipements pour opérations sur véhicules électriques & hybrides -
Ausrüstung für den Betrieb von Elektro- und Hybridfahrzeugen

FACE SHIELD WITH HEADBAND
- ÉCRAN FACIAL AVEC SERRE-TÊTE
068018



INSULATING GLOVES (T10)
- GANTS ISOLANTS (T10)
068025



25 pieces insulated tools 1000V - Coffret de 25 outils isolés 1000V
- Box mit 25 isolierten Werkzeugen 1000V
066489



- | | |
|--|-----|
| 7/8/10/12/14/15/17/19/22 mm sockets
- Douilles 7/8/10/12/14/15/17/19/22 mm | x 9 |
| 175 mm universal pliers in chrome vanadium
- Pince universelle de 175 mm en chrome vanadium | x 1 |
| Cutting pliers 150 mm in chrome vanadium
- Pince coupante 150 mm en chrome vanadium | x 1 |
| 3/8" ratchet - Cluqlet en 3/8" | x 1 |
| Extension 100 mm - Rallonge 100 mm | x 1 |
| T-handle - Poignée en T | x 1 |
| Open ended wrenches 7/8/10/12/14/17 mm
- Clés plates à fourches 7/8/10/12/14/17 mm | x 6 |
| Cable knife - Couteau pour câble | x 1 |
| Philips PhH1x100/PhH2x100 mm screwdriver
- Tournevis Phillips PhH1x100/PhH2x100 mm | x 2 |
| Flat screwdriver 5.5x125 / 4x100 mm
- Tournevis plats 5.5x125/4x100 mm | x 2 |



Kit for marking the area of intervention
- Kit pour le balisage de la zone d'intervention
- Kennzeichnungsset für Hochvolt-Bereiche
064409



- | | |
|---|-----|
| Red and white warning pole - Balise de signalisation rouge et blanche | x 4 |
| Red and white bounding line - Chaîne de délimitation rouge et blanche | x 1 |
| Sign board "Danger, working area EHV" - Pancarte de signalisation "Danger, zone de travail VEH" | x 2 |



TROUSERS - Pantalon - Hose



- | | | |
|---------------------------------------|------------------------------------|-----------------------|
| 98% cotton,
2% antistatic | EN ISO 11611
Class 2-A1
& A2 | S (40/42)
046368 |
| EN ISO 11612
A1+A2-B1-
C1-E3-F1 | EN 1149-5 | M (44/46)
046375 |
| IEC 61482-2
Class 1-4kA | EN 14404
+A1
Type 2 | L (48/50)
046382 |
| | | XL (52/54)
046399 |
| | | XXL (56/58)
046412 |

JACKET - Veste - Jacke



- | | | |
|---------------------------------|-----------------------------------|-----------------------|
| 98% cotton, 2% antistatic | EN ISO 11612
A1+A2-B1-C1-E3-F1 | S (40/42)
046313 |
| EN ISO 11611
Class 2-A1 & A2 | EN 14404
+A1
Type 2 | M (44/46)
046320 |
| IEC 61482-2
Class 1-4kA | EN 1149-5 | L (48/50)
046337 |
| | | XL (52/54)
046344 |
| | | XXL (56/58)
046351 |

HEAT COVER - Couverture anti-chaueur - Hitzeschutzdecke - Manta anti-calor - Protecção anti-aquecimento



PROTEC 550
550°C/1000°F - Class M0
2 m x 2 m - 580 g/m²
050495

PROTEC 1200
1200°C/2200°F - Class M0
1.75 m x 1.5 m - 1200 g/m²
050204

PROTEC 1300
1300°C/2400°F - Class M0
XL : 2 m x 1.8 m - 620 g/m²
053595

PROTEC 1300L
1300°C/2400°F
XL : 2 m x 1.8 m - 427 g/m²
060500

SET OF 2 MAGNETS

- Jeu de 2 aimants
- Schweißmagnet



(x2)
052291

MAGNETIC COVER - Couverture magnétique - Magnetschutzdecke



1.06 m x 0.6 m
061446

RIDEAU DE SOUDAGE - Welding curtain and frame - Schweißerschutzwand

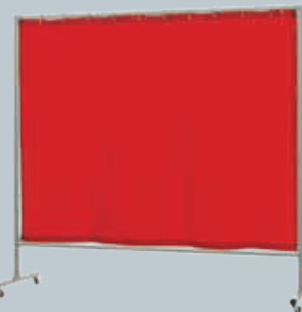

OPTI 215.0
Orange CE - 2 x 2.15 m
EN 25980 - 2015/01
060470



OPTI 200G
Green T9 - 2 x 2 m
EN 25980 - 2015/01
060463

RESPIRATORY MASKS - Masques respiratoires - Atemschutzmaske - Máscaras respiratorias



FFP3 - EN 140 / EN 143 / EN 166
(x1) Size M/L
037021



FFP3 - EN 140 / EN 143
(x1) Size M/L
037014



Étui / Case
037045



FFP3 - EN 143 : 2000 P3
Anti poussières / Anti odeurs
037038

PROTECTION GOGGLES

- Lunettes de protection - Schutzbrillen

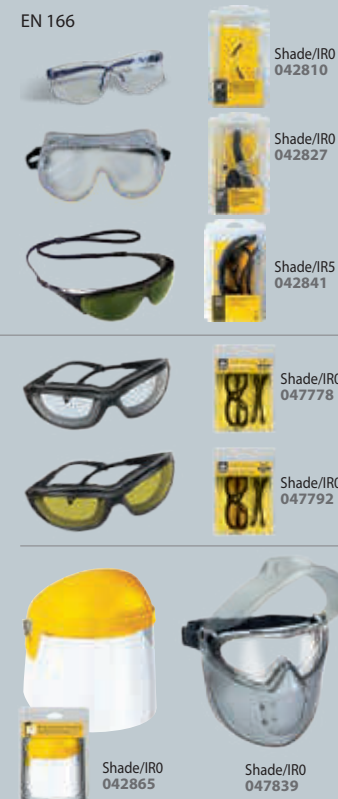

EN 166
Shade/RO 042810
Shade/RO 042827
Shade/RS 042841
Shade/RO 047778
Shade/RO 047792
Shade/RO 042865
Shade/RO 047839

GLOVES - Gants - Handschuhe - Guantes



Anti-cut - Anti coupure T9 045897
EN388 4342
✓ touch screen friendly - écran tactile - High resistance anti-cut Anti coupure haute résistance EN 420 EN 388:4121 T9 : 045910 T10 : 045927
High dexterity anti-cut - Anti coupure haute dextérité EN 420 EN 388:1121 T9 : 045903 T10 : 045934
T10 064188
EN420 2003
Ultra Flexible EN388 2003
Heavy Duty T10 (MMA - MIG - Plasma) 045101
EN388 4244
EN 407 424X4X EN12477 Class : A1
Gants PRO TIG T10 045194
EN388 2122
EN 407 322X2X EN12477 Class : A1
Cuir Leather
PRO 045217
EN388 4244
EN 407 424X4X EN12477 Class : A1
Gants PRO TIG EXTRA T10 045323
EN388 2011XX
EN 407 41313X EN12477-B EN 420

MULTI-USE LEATHER APRON

- Tablier cuir multi-usage
- Delantal de cuero multi-uso
- Mehrzweck-Lederschürze



Cuir Leather
Leder

PRO 045217



★★★★★ **THEY TRUST US** ★★★★★

ILS NOUS FONT CONFIANCE

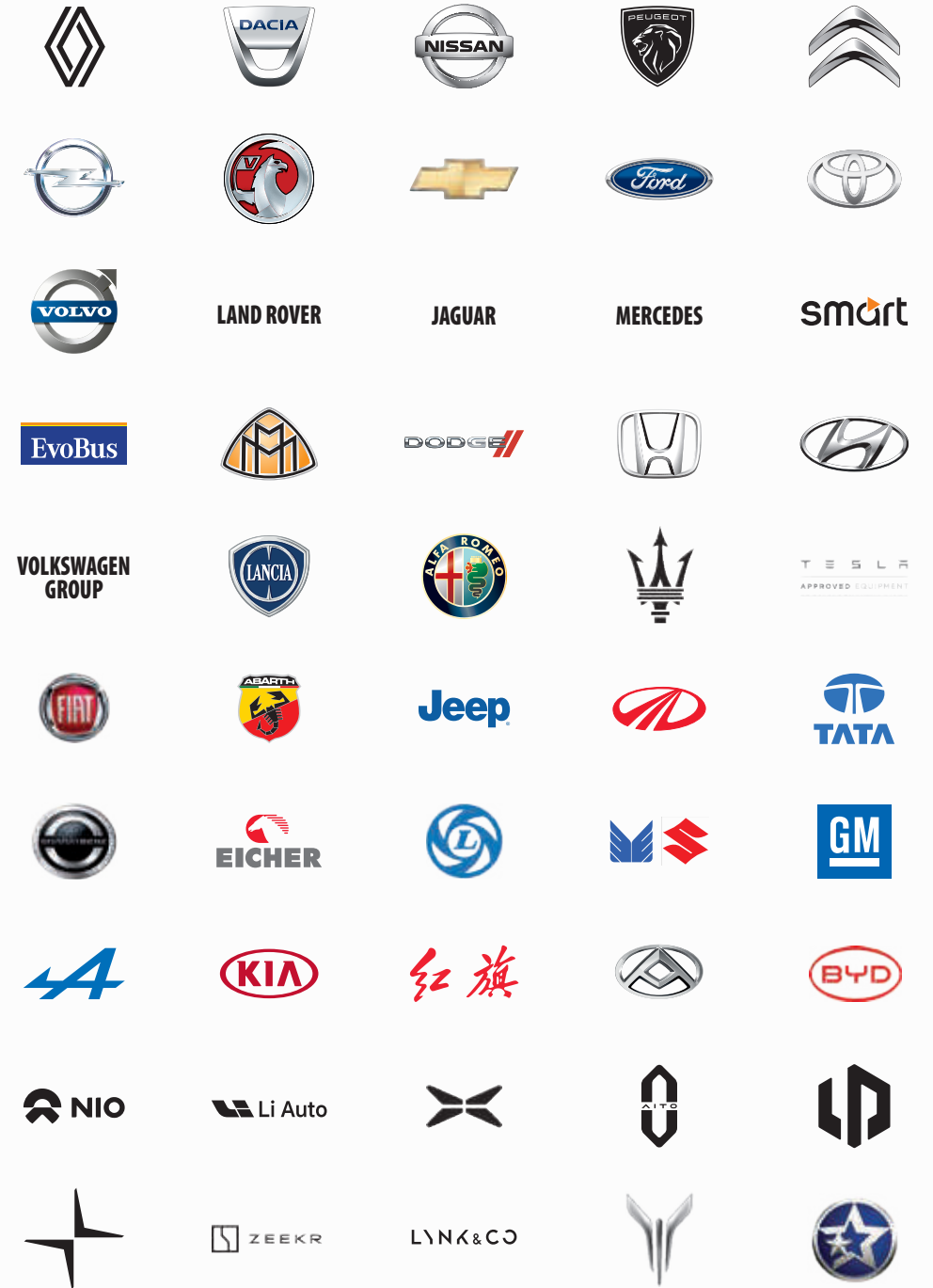



INVEST IN THE FUTURE



French manufacturer
since 1964

2
0
2
4
B

Collision Repair

Solutions Réparation Carrosserie
Karosseriereparatur
Attrezzature Riparazione Carrozzerie
Reparación de Carrocería



LinkedIn
 Youtube
 WeChat
 Facebook
 Instagram

www.gys.fr



GYS FRANCE

HEADQUARTERS

1 rue de la Croix des Landes
CS 54159
53941 Saint-Berthevin - Cedex
Laval - France
Tel +33 2 43 01 23 60
E-mail service.client@gys.fr



ZI, 134 bd des Loges
53941 Saint-Berthevin
Laval - France

LOGISTIC CENTER

2 Rue Jean Dausset
53810 Changé - France
Tel +33 2 43 01 54 33



GYS GERMANY

Professor-Wieler
Straße 11
52070 Aachen
Deutschland

Tel +49 241/189-23-710
Fax +49 241/189-23-719
E-mail aachen@gys.fr



GYS UK

Unit 3 - Great Central Way
Rugby - Warwickshire
CV21 3XH
United Kingdom

Tel +44 1926 338 609
Fax +44 1926 429 764
E-mail uk@gys.fr



GYS ITALIA

Via Porta Est, 7
30020 Marcon - VE
Italia

Tel +39 041 53 21 565
E-mail italia@gys.fr



GYS IBÉRICA

Avenida Pirineos 31
Nave 9
San Sebastian de los Reyes
28703 Madrid
España

Tel +34 917 409 790
E-mail iberica@gys.fr



GYS CHINA

Lot N°15
6666 bd Songze
201706 Qingpu
Shanghai
China

Tel +86 6221 4461
Fax +86 5226 0067
www.gys-china.com.cn
E-mail
contact@gys-china.com.cn

MARKETING

Display stand
- Podium de
présentation
- Podest

PODIUM 1
A : 45 cm
B : 50 cm
C : 50 cm
063204

PODIUM 2
A : 80 cm
B : 50 cm
C : 50 cm
063211

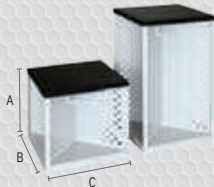

Flag -
Oriflamme
3 x 0,50 m
098015



Barnum
3 x 3 m
098022



Open barnum
2 x 2 m
098039



Retail display
space with 2
shelves
- Linéaire de vente
avec 2 étagères
- Lochwandregal
mit 2 Böden
(machines not
included)
060784



Distributed by

